

Grove Base Kit for Raspberry Pi

SKU 110020169

The Grove Base Kit for Raspberry Pi is one of the best kits for beginners to get started with Raspberry Pi. No troublesome soldering and no complicated wiring. You can focus on learning Raspberry Pi. This kit includes a **Grove Base Hat for Raspberry Pi** and 10 Grove modules, which covering sensor, actuator and display. All you need to do is following the demo, plug the module into the Grove Base Hat, truly plug and play.

On top of that, we have provided you with detailed instructions on the use of Raspberry Pi and the use of each module, which including 8 lessons for module. Just click the **LEARN** tab to view this user manual. Also you can check the Vedio Guide [here](#), which will tell you how to use this kit step by step.

All in all, whether you are a student, teacher, artist, hardware enthusiast, and so on, with the help of the Grove Base Kit for Raspberry Pi, you will get to know Raspberry Pi quickly and comprehensively.

Part List

- Grove Base Hat for Raspberry Pi
- Grove - Red LED Button
- Grove - Buzzer
- Grove - Moisture Sensor
- Grove - Temperature & Humidity Sensor (DHT11)
- Grove - Light Sensor
- Grove - mini PIR motion sensor
- Grove - Ultrasonic Ranger
- Grove - Relay
- Grove - Servo
- Grove - 16 x 2 LCD (White on Blue)

ECCN/HTS

ECCN	EAR99
HSCODE	9023009000
UPC	

Grove Base Kit for Raspberry Pi

GROVE SYSTEM

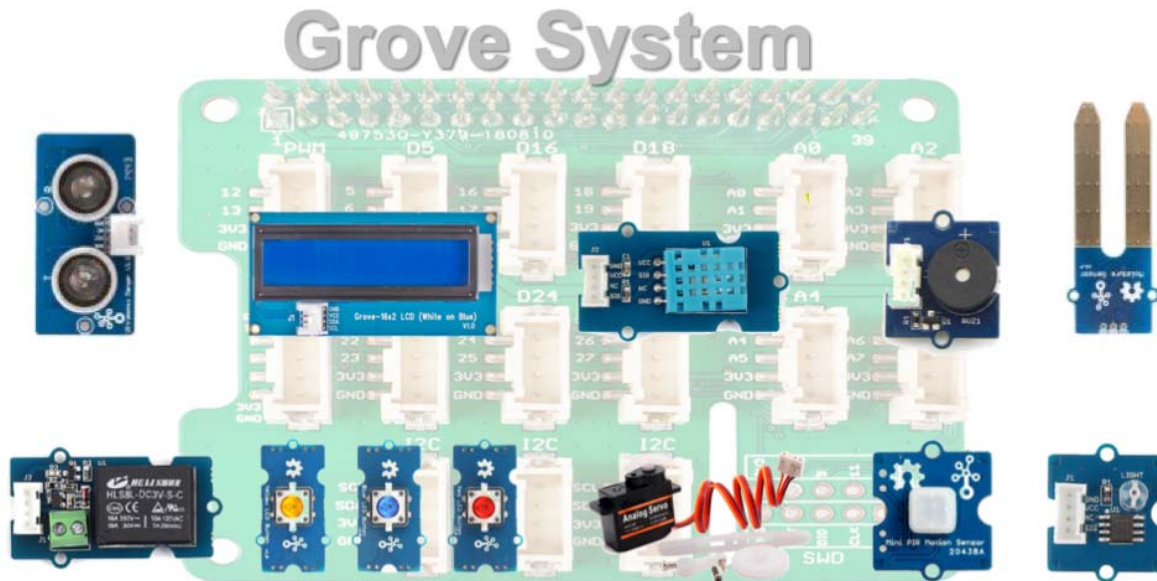

Grove is a modular prototyping system consist of a base unit and various modules with standardized connector. The base unit is generally a microprocessor which allows for communicates, processes and controls the input or output from the Grove modules. Every single Grove module typically addresses a single function, range from a simple button to a more complex heart rate sensor. the standardised Grove connector allows user to assemble Grove units with building block approach, compared to the jumper or solder based system it is much easier to assemble or disassemble, which simplifies the learning system for experimenting, building and prototyping. We also provide Grove to Pin Header Converter or Grove Base HAT available for variety developing platforms for those who wants to use grove sensor and actuator modules without Grove System Development Board.

Grove system users need to have at least some basic electronic knowledge background, otherwise you need go through this basic tutorial to learn some basic operations on the Grove system, the first part of this tutorial consists a list of basic information on the components included in the starter kit, followed by the basic setup of the Arduino IDE for Seeeduino Lotus. Then, the 11 tutorial sessions provide the basic operation on each individual components in the starter kit and the applications by combine multiple modules together, which gives learner some insight and basic knowledge on hooking up and coding with the Grove system.

GROVE BASE KIT FOR RASPBERRY PI

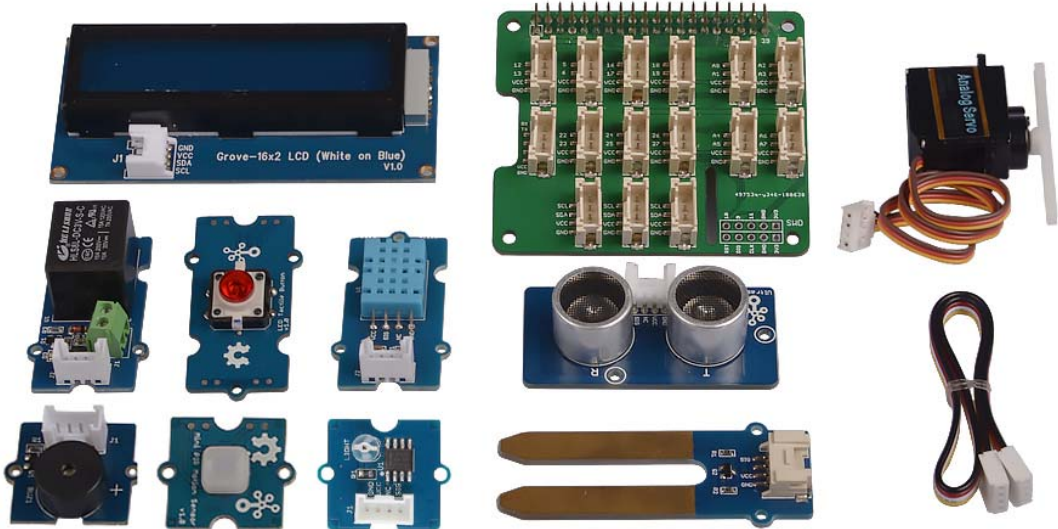

Grove start kit contains one Grove Base Hat(for Raspberry Pi) and 10 Grove modules. The detailed information is listed below.

Product Detail

Grove Base Hat

Grove Base Hat for Raspberry Pi

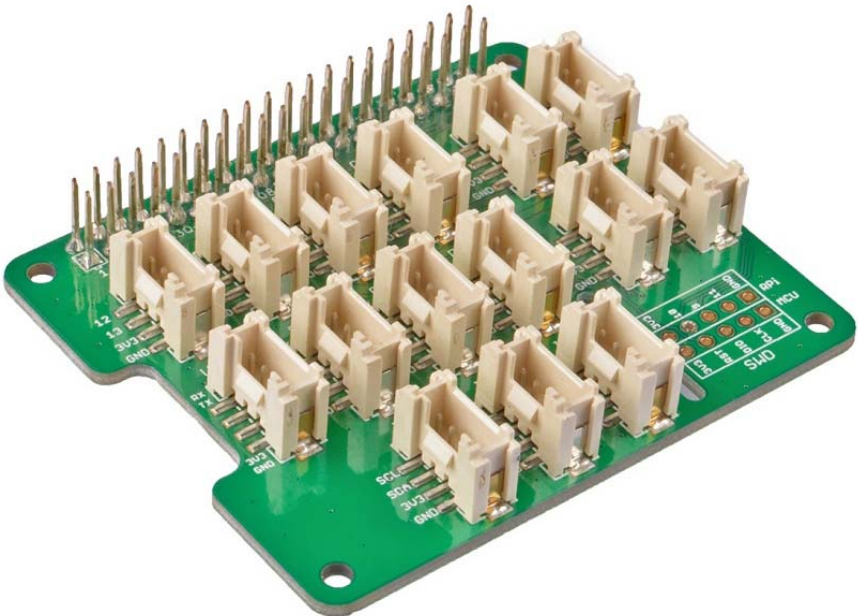

Today, the grove series of sensors, actuators, and displays have grown into a large family. More and more grove modules will join the Grove ecosystem in the future. We see the Grove helps makers, engineers, teachers, students and even artists to build, to make, to create...We always feel it is our responsibility to make the Grove module compatible with more platforms. Now we bring you the Grove Base Hat for Raspberry Pi and Grove Base Hat for Raspberry Pi Zero, in another word, we bring the Raspberry Pi the Grove System.

The Grove Base Hat for Raspberry Pi provide Digital/Analog/I2C/PWM/UART port to meet all your needs. With the help of build-in MCU, a 12-bit 8 channel ADC is also available for Raspberry Pi.

Features

- Support Raspberry Pi 2B/3B+/Zero
- build-in MCU
- 12-bit ADC
- Multi-type Grove port

Hardware Overview

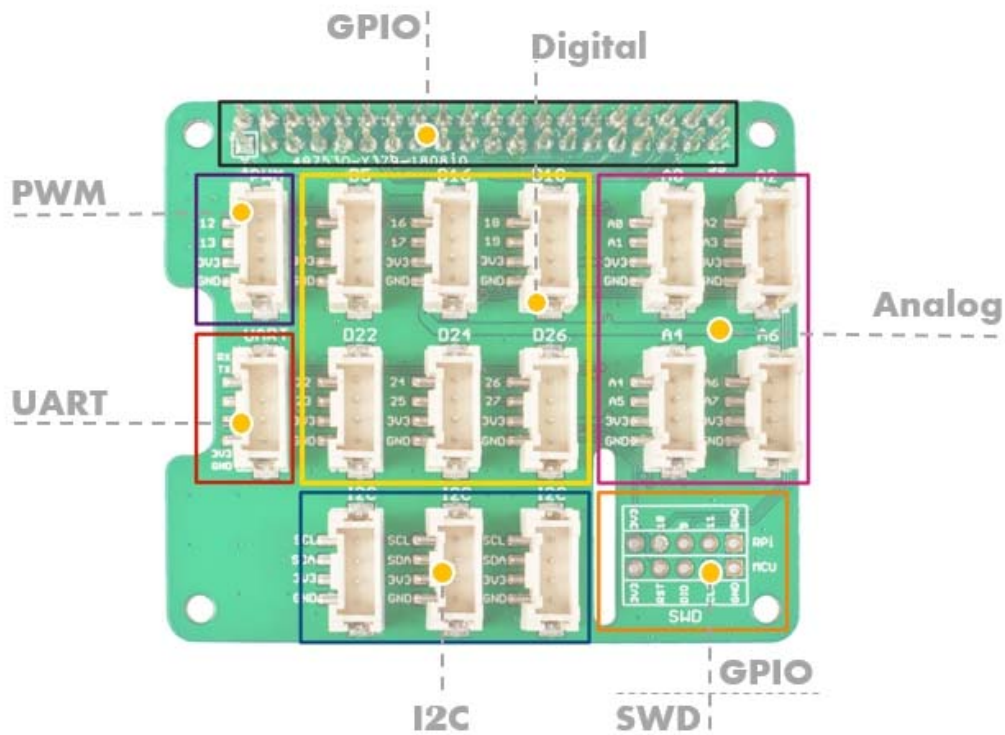

GPIO : The same pin out as the raspberry pi.

PWM : The Grove PWM Port connect to GPIO/BCM pin12(PWM0) and GPIO/BCM pin13(PWM1), which is the hardware PWM pin of Raspberry Pi, in addition, you can use all the GPIO pin as the soft PWM pin.

Note

- All the silkscreen layer pin number besides the Grove port is the BCM pin number. The difference between BCM pins and the physical pins please refer to [here](#)
- Compared with hardware PWM, the software PWM isn't so accurate and will have trouble at high frequencies.
- The GPIO/BCM pin18 is also marked as PWM0, actually the GPIO/BCM 12 and the GPIO/BCM 18 share the same PWM channel, so they can't set to different rate.
- The audio jack output also uses PWM 0 and PWM 1, so you can't have audio output on that socket and use the PWMs at the same time.

UART: The Grove UART port connect to the GPIO14(UART0 TX) and GPIO15(UART0 RX). UART is commonly used on the Pi as a convenient way to control it over the GPIO, or access the kernel boot messages from the serial console (enabled by default).It can also be used as a way to interface an Arduino, bootloaded ATmega, ESP8266, etc with your Pi.

Digital : There are 6 digital Grove sockets in this board, normally the yellow wire(which connect to the top pin of the 4 pins Grove socket as) of Grove cable is the signal wire, so we name the digital Grove port D5/D16/D18/D22/D24/D26.

Analog : As we know, there is no ADC in the Raspberry Pi, so it can not work with analog sensor directly. Now with the help of the build-in MCU STM32, the Grove base hat can work as an external 12-bit ADC, which means you can use analog sensor with your Raspberry Pi. Even more pleasing is that not one but four analog Grove sockets are available. The analog sensor inputs the analog voltage into the 12-bit ADC. After the ADC convert the analog data to digital data, it input the digital data to the Raspberry Pi through the I2C interface.

I2C : There are three I2C port available in this board, they all connect to the I2C pin of the raspberry directly. You can consider this part as an I2C hub. Most of seeed's new grove modules have I2C interface, you may find those three port is extremely useful.

SWD : We use SWD port to burn the firmware to this hat. In addition, you can see 3 GPIO pins in this section, i.e., pin 9/pin 10/pin 11. Those three pins do not used by any Grove port, you are free to use them without worrying about pin conflicts.

Grove Modules

Grove - Buzzer

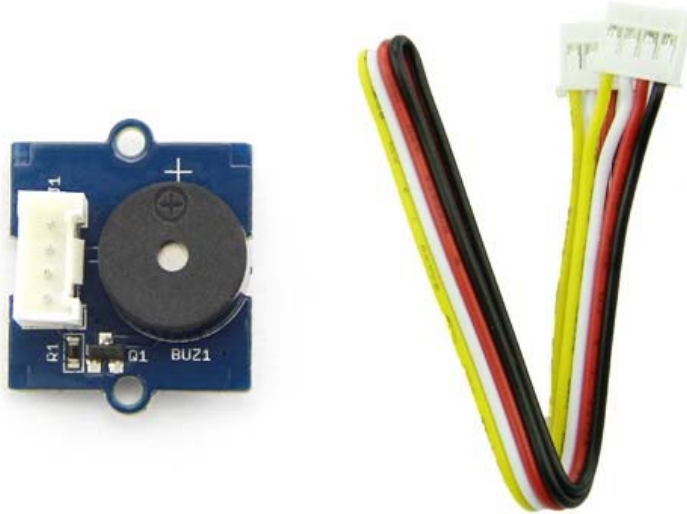

This module uses piezo buzzer as the main component, it can produce high pitch tone while it is connected to digital output and logic level set to High, otherwise it can produce various tones according to the frequencies generated from the Analog PWM output that connected to it. (note: the frequency range that normal human ear can distinguish is between 20 Hz and 20kHz.)

Grove - Red LED Button

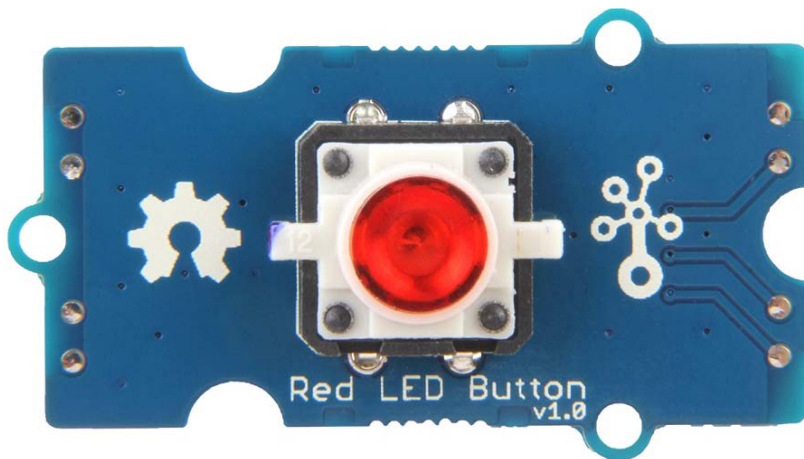

The Grove - LED Button is composed of Grove - Yellow Button, Grove - Blue LED Button and Grove - Red LED Button. This button is stable and reliable with a 100 000 times long life. With the build-in LED, you can apply it to many interesting projects, it is really useful to use the LED to show the status of the button.

Grove - Light Sensor

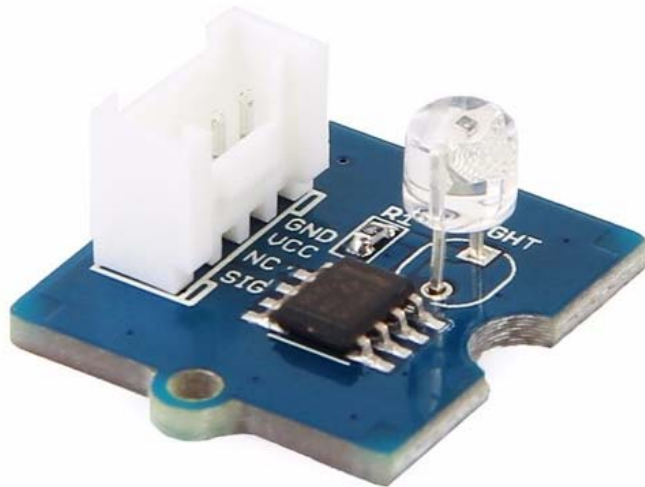

The Grove - Light sensor integrates a photo-resistor(light dependent resistor) to detect the intensity of light. The resistance of photo-resistor decreases when the intensity of light increases. A dual OpAmp chip LM358 on board produces voltage corresponding to intensity of light(i.e. based on resistance value). The output signal is analog value, the brighter the light is, the larger the value.

Grove - Moisture Sensor

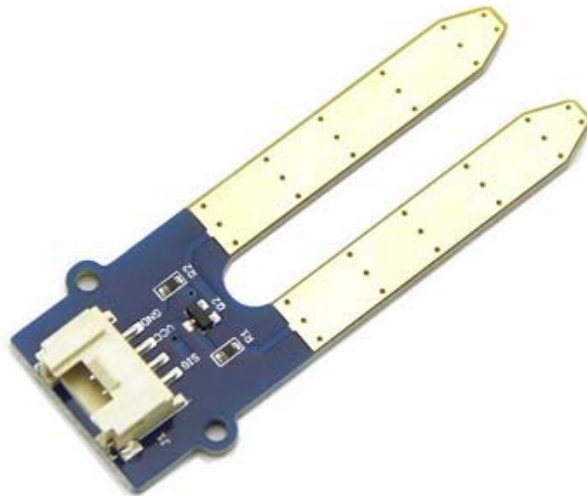

This Moisture Sensor can be used for detecting the moisture of soil or judge if there is water around the sensor, let the plant in your garden able to reach out for human's help when they are thirsty. This sensor is very easy to use, you can just simply insert in into the soil and read the data. With this sensor, you can make a small project that can let the plant send a message to you like " I am thirsty now, please feed me some water."

Grove - mini PIR motion sensor

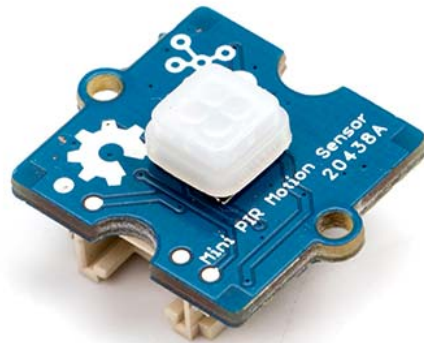

Grove - mini PIR motion sensor allows you to sense motion, usually human movement in its range. Simply connect it to Grove - Base shield and program it, when anyone moves in its detecting range, the sensor will output HIGH on its SIG pin.

Grove - Servo



Grove - Servo is DC motor with gearing and feedback system. It is used in driving mechanism of robots. The module is a bonus product for Grove lovers. We regulated the three-wire servo into a Grove standard connector. You can plug and play it as a typical Grove module now, without jumper wires clutter.

Grove - Temperature & Humidity Sensor (DHT11)

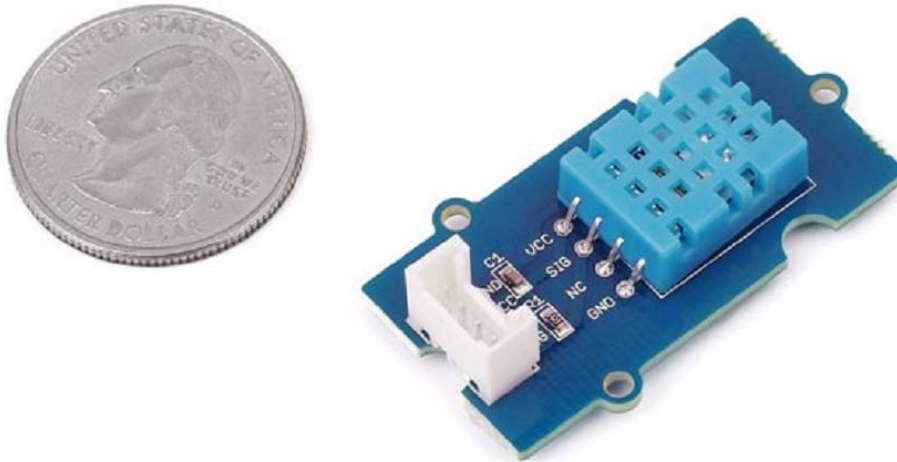

This temperature & humidity sensor provides a pre-calibrated digital output. A unique capacitive sensor element measures relative humidity and the temperature is measured by a negative temperature coefficient (NTC) thermistor. It has excellent reliability and long term stability. Please note that this sensor will not work for temperatures below 0 degree.

Grove - Relay



The Grove-Relay module is a digital normally-open switch. Through it, you can control circuit of high voltage with low voltage, say 5V on the controller. There is an indicator LED on the board, which will light up when the controlled terminals get closed.

Grove - Ultrasonic Ranger



This Grove - Ultrasonic ranger is a non-contact distance measurement module which works at 40KHz. When we provide a pulse trigger signal with more than 10uS through signal pin, the Grove_Ultrasonic_Ranger will issue 8 cycles of 40kHz cycle level and detect the echo. The pulse width of the echo signal is proportional to the measured distance. Here is the formula: $\text{Distance} = \text{echo signal high time} * \text{Sound speed} (340\text{M/S})/2$. Grove_Ultrasonic_Ranger's trig and echo signal share 1 SIG pin.

Grove - 16 x 2 LCD (White on Blue)



This Grove - 16x2 LCD module is a 16 Characters 2 Lines LCD display, it uses I2C bus interface to communicate with the development board, thus these will reduce the pin header from 10 to 2 which is very convenient for the Grove system. This LCD display module also supports customise characters, you can create and display heart symbol or stick-man on this LCD module through a simple coding configuration.

GETTING STARTED

Minimum Requirement

- micro USB cable
- Raspberry Pi
- SD card
- Grove Base Kit for Raspberry Pi

Basic Tutorial

[Arduino IDE basic setup](#)

[How to burn a Raspbian image](#)

1. Raspbian Stretch download



Download **Raspbian Stretch** from Raspberry Pi official website and select “with desktop and recommended software” version.

Raspbian

Raspbian is the Foundation's official supported operating system. You can install it with [NOOBS](#) or download the image below and follow our [installation guide](#).

Raspbian comes pre-installed with plenty of software for education, programming and general use. It has Python, Scratch, Sonic Pi, Java and more.

The Raspbian with Desktop image contained in the ZIP archive is over 4GB in size, which means that these archives use features which are not supported by older unzip tools on some platforms. If you find that the download appears to be corrupt or the file is not unzipping correctly, please try using [7Zip](#) (Windows) or [The Unarchiver](#) (Macintosh). Both are free of charge and have been tested to unzip the image correctly.

	Raspbian Stretch with desktop and recommended software Image with desktop and recommended software based on Debian Stretch Version: November 2018 Release date: 2018-11-13 Kernel version: 4.14 Release notes: Link Download Torrent Download ZIP		Raspbian Stretch with desktop Image with desktop based on Debian Stretch Version: November 2018 Release date: 2018-11-13 Kernel version: 4.14 Release notes: Link Download Torrent Download ZIP
---	--	---	--

SHA-256: 00a644539fdaf4e19ec7ceb9e61c049b82ba45b1a21cdec91fa54bd59d660d2

	Raspbian Stretch Lite Minimal image based on Debian Stretch Version: November 2018 Release date: 2018-11-13 Kernel version: 4.14
---	---

SHA-256: a121652937c0de1c2583fe77d1caec407f20d248327df2901e4716649ac9bc97

2. Win32 Disk Imager

- Download the [Win32 Disk Imager](#) from the Sourceforge Project page as an installer file, and run it to install the software.
- Insert the SD card into your SD card reader and connect to your PC.
- Run the Win32DiskImager utility from your desktop or menu.
- In the device box, select the corresponding drive letter of the SD card. Be careful to select the correct drive: if you choose the wrong drive you could destroy the data on your computer's hard disk! If you are using an SD card slot in your computer, and can't see the drive in the Win32DiskImager window, try using an external SD adapter.
- Click 'Write' and wait for the write to complete.

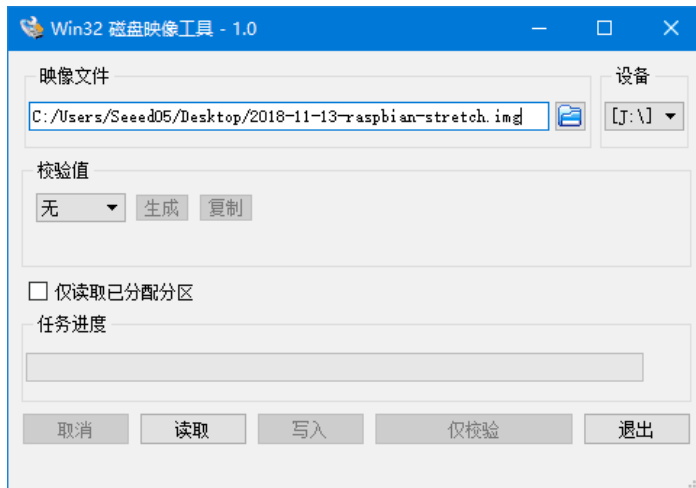

- Complete.

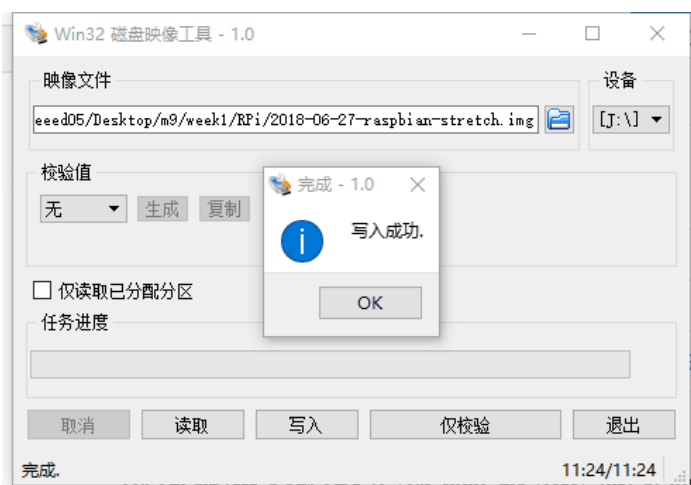

- Exit the imager and eject the SD card.

Basic Configuration

Wireless connection and SSH

1. Create a file called "wpa_supplicant.conf" into the /boot folder, and copy the following code.

```
1country=CN
2ctrl_interface=DIR=/var/run/wpa_supplicant GROUP=netdev
3update_config=1
4
5network={
6ssid="WiFi-name"
7psk="WiFi-password"
8key_mgmt=WPA-PSK
9priority=1
10}
```

Note

The Wi-Fi name and password should be the same as your local Wi-Fi which your PC connected to(make sure your PC and Raspberry Pi are in the same LAN).

2. Create a blank file called "ssh" into the /boot folder.
3. Insert the SD Card with Raspbian into the Raspberry Pi

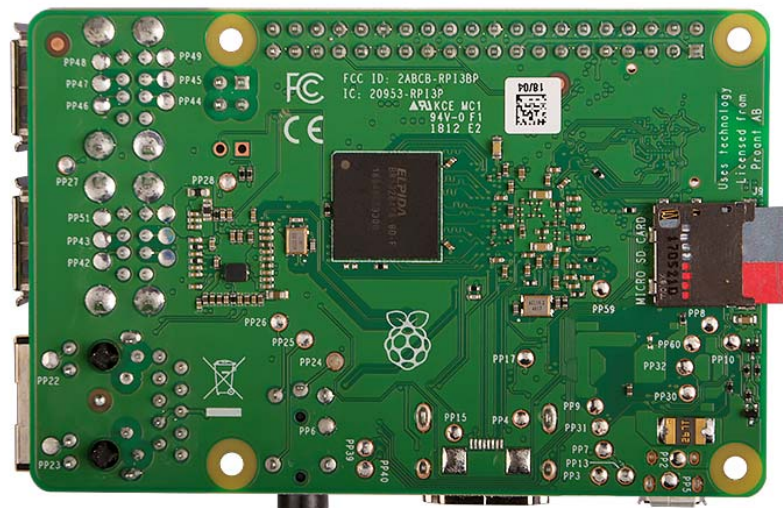

4. Connect the Raspberry Pi to the power source and power it up.

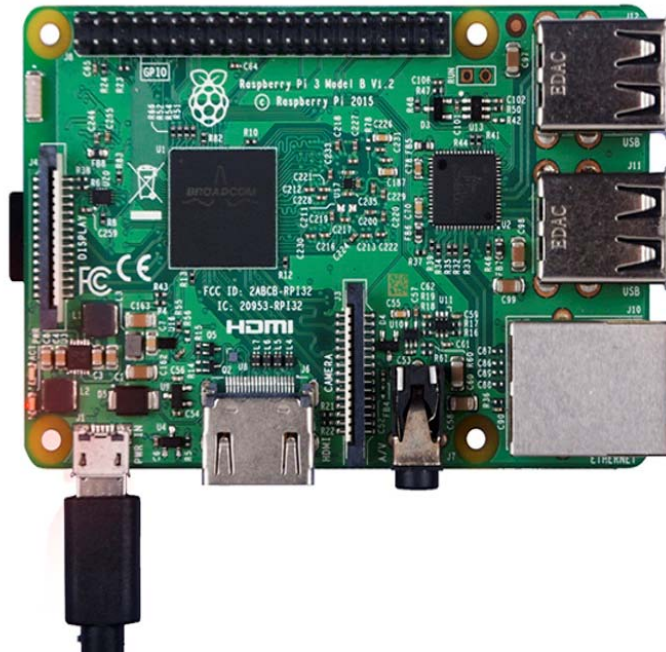

5. Open putty to connect PC to Raspberry Pi.

Download putty : <https://www.chiark.greenend.org.uk/~sgtatham/putty/latest.html>

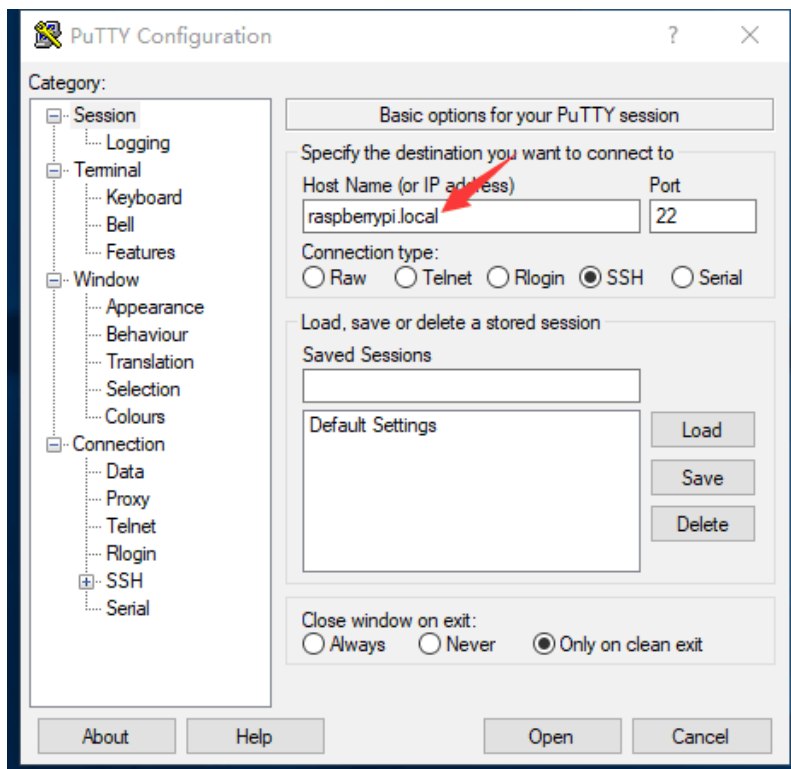

Raspberry Pi Default username : pi Default password : raspberry

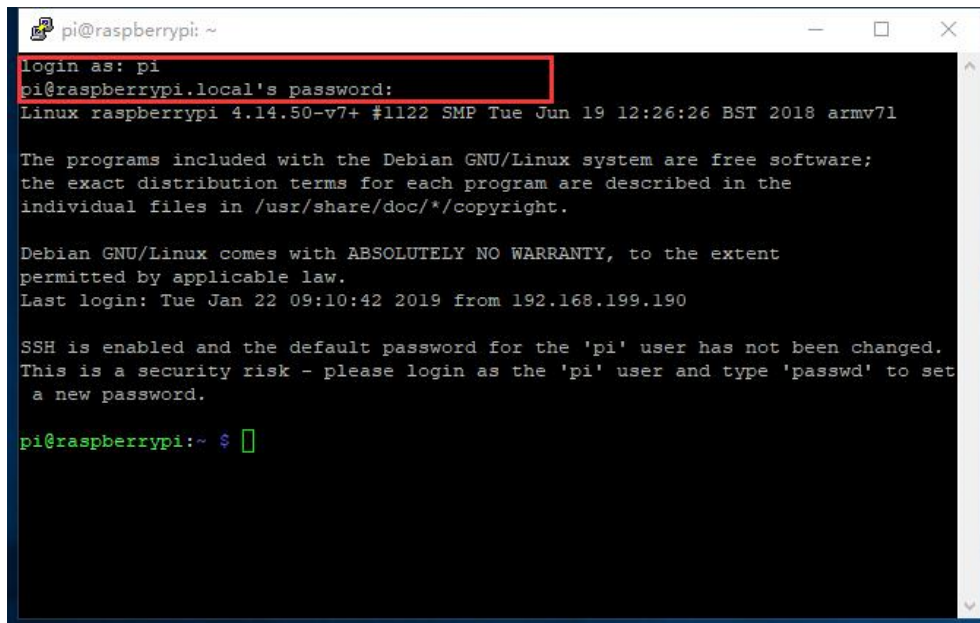

```
pi@raspberrypi: ~  
login as: pi  
pi@raspberrypi.local's password:  
Linux raspberrypi 4.14.50-v7+ #1122 SMP Tue Jun 19 12:26:26 BST 2018 armv7l  
  
The programs included with the Debian GNU/Linux system are free software;  
the exact distribution terms for each program are described in the  
individual files in /usr/share/doc/*/copyright.  
  
Debian GNU/Linux comes with ABSOLUTELY NO WARRANTY, to the extent  
permitted by applicable law.  
Last login: Tue Jan 22 09:10:42 2019 from 192.168.199.190  
  
SSH is enabled and the default password for the 'pi' user has not been changed.  
This is a security risk - please login as the 'pi' user and type 'passwd' to set  
a new password.  
  
pi@raspberrypi:~ $
```

VNC Configuration

1. Open raspi-config by typing following command in terminal.

```
lsudo raspi-config
```

Arrow down to 5 interfacing Options and press "enter" to select.

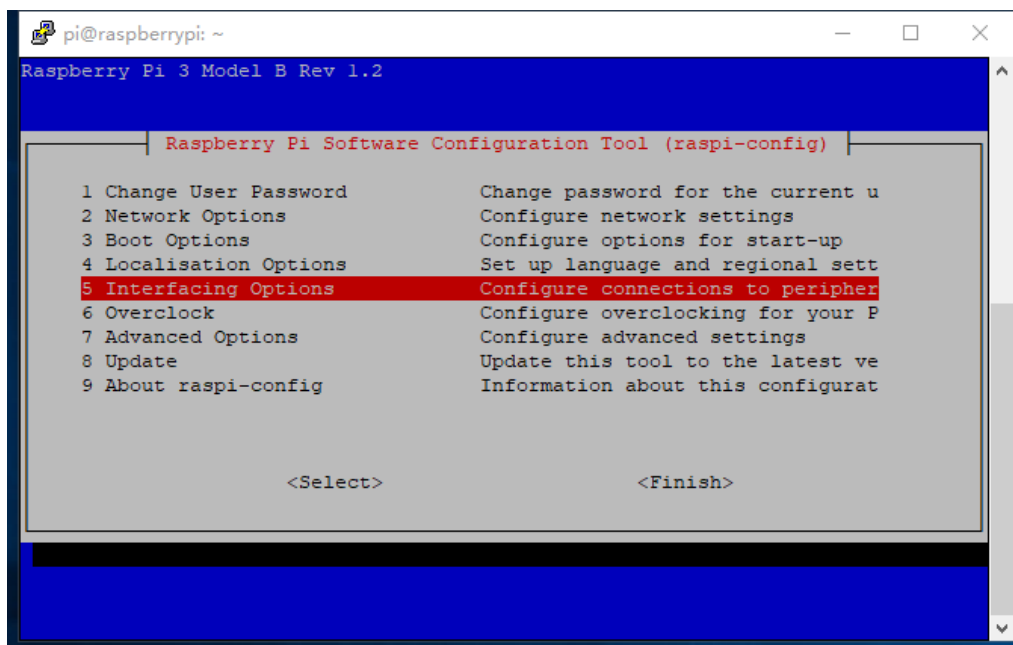

```
pi@raspberrypi: ~  
Raspberry Pi 3 Model B Rev 1.2  
  
Raspberry Pi Software Configuration Tool (raspi-config)  
  
1 Change User Password          Change password for the current u  
2 Network Options              Configure network settings  
3 Boot Options                 Configure options for start-up  
4 Localisation Options         Set up language and regional sett  
5 Interfacing Options          Configure connections to peripher  
6 Overclock                    Configure overclocking for your P  
7 Advanced Options             Configure advanced settings  
8 Update                       Update this tool to the latest ve  
9 About raspi-config           Information about this configurat  
  
<Select>                       <Finish>
```

Arrow down to P3 VNC and press "enter" to select.

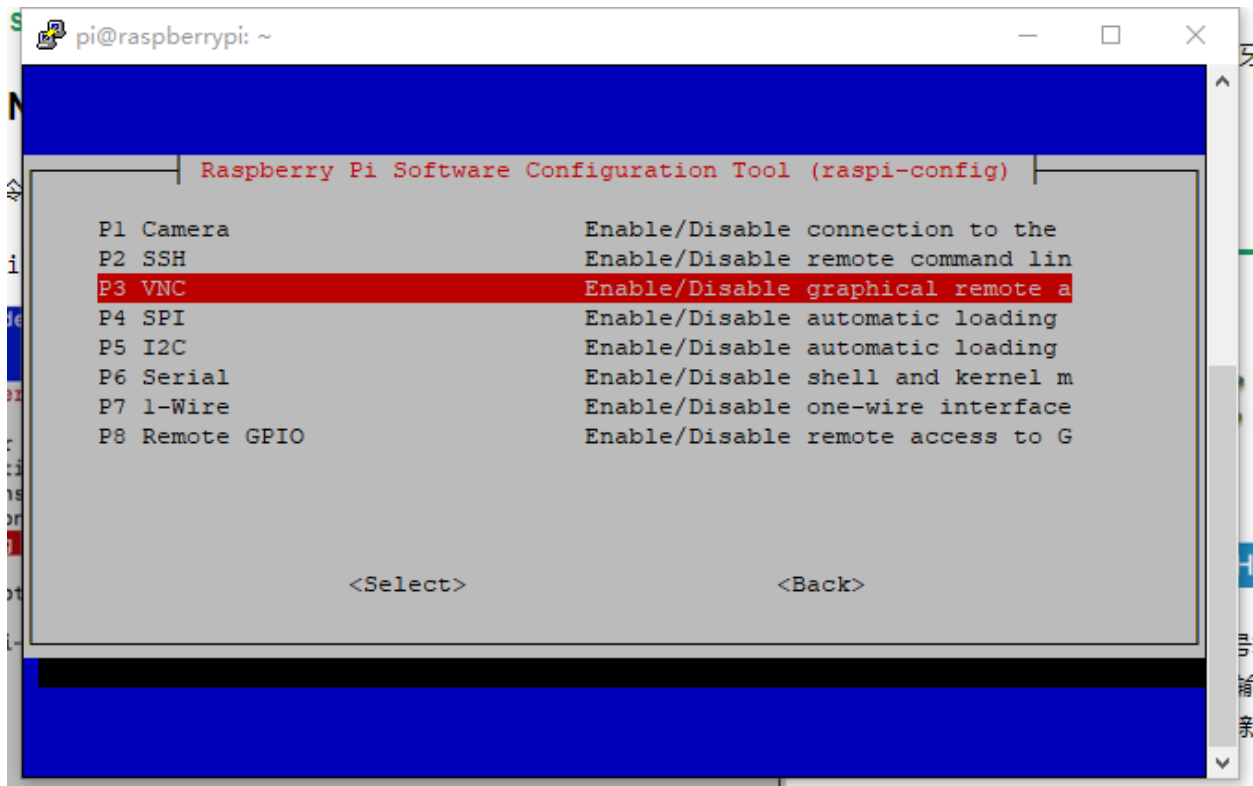

Select "Yes" to enable it.

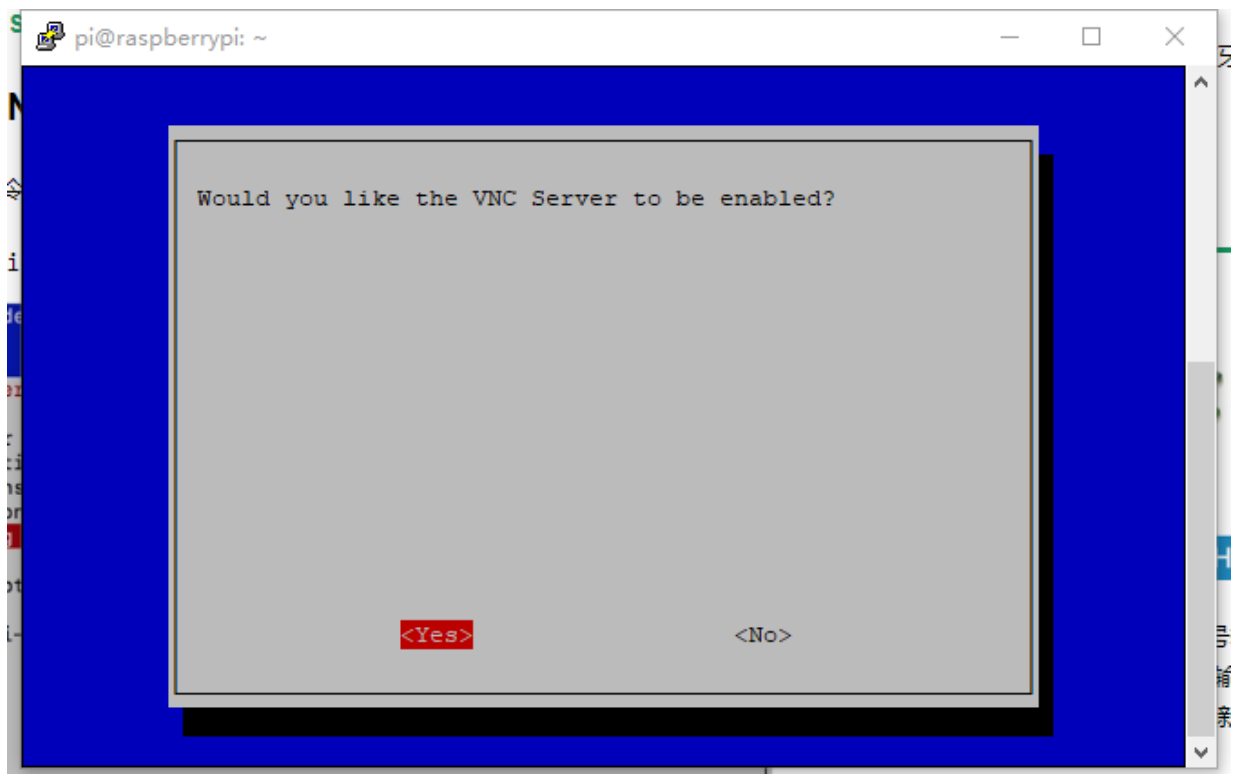

Select "Ok".

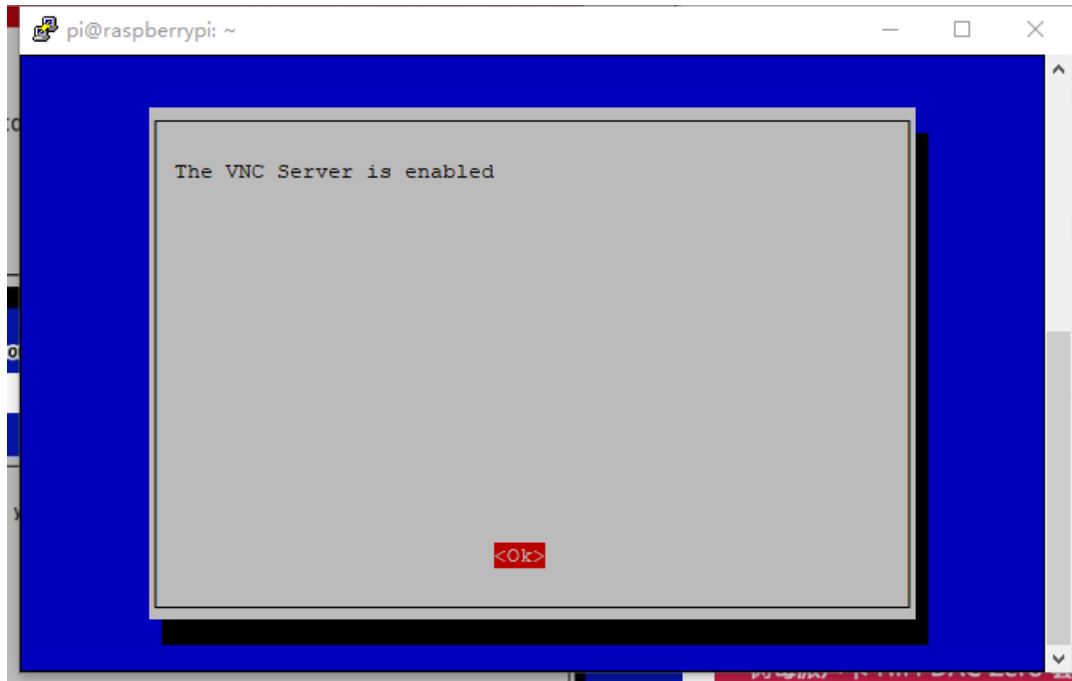

****2. ** Install VNC Viewer**

Downloadr [VNC Viewe](#)

Download VNC Viewer to the device to control from

Make sure you've downloaded [VNC Connect](#) to the computer you want to control.

Windows macOS Linux Raspberry Pi iOS Android Chrome Solaris
HP-UX AIX

Download VNC Viewer

SHA-256: 1f7ea51b3061183fb3b8a49dddc26014439d856eb35417aed0f50332dc868e7c

EXE x86/x64

Open VNC Viewer and enter the IP address of Raspberry Pi. You can find the IP address by typing ++ifconfig++ command in the terminal of Raspberry Pi (or you can enter raspberrypi.local).

Note

If you use raspberrypi.local to login your Pi, you should make sure there is only one Raspberry Pi in use in your LAN.

Enter the default user name and password, and now you can enter the Raspberry Pi's remote desktop!

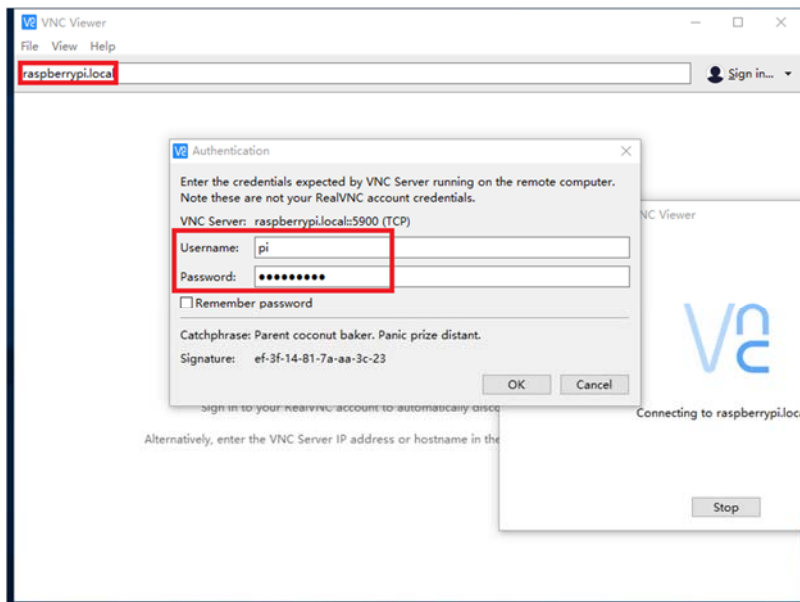

Success !

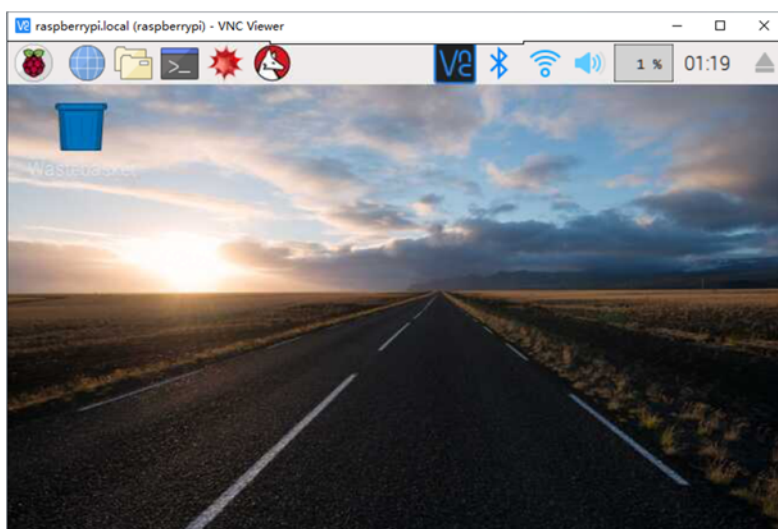

Base Hat Configuration

1. Shutdown the Raspberry Pi

```
1sudo shutdown -h now
```

Plug the Grove Base Hat for Raspberry Pi into the Raspberry Pi.

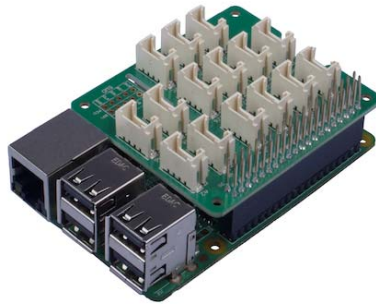

****2. **Power up the Raspberry Pi with micro-usb cable to enable I2C**

Open raspi-config by typing following command in terminal.

```
1sudo raspi-config
```

Arrow down to 5 interfacing Options and press "enter" to select.

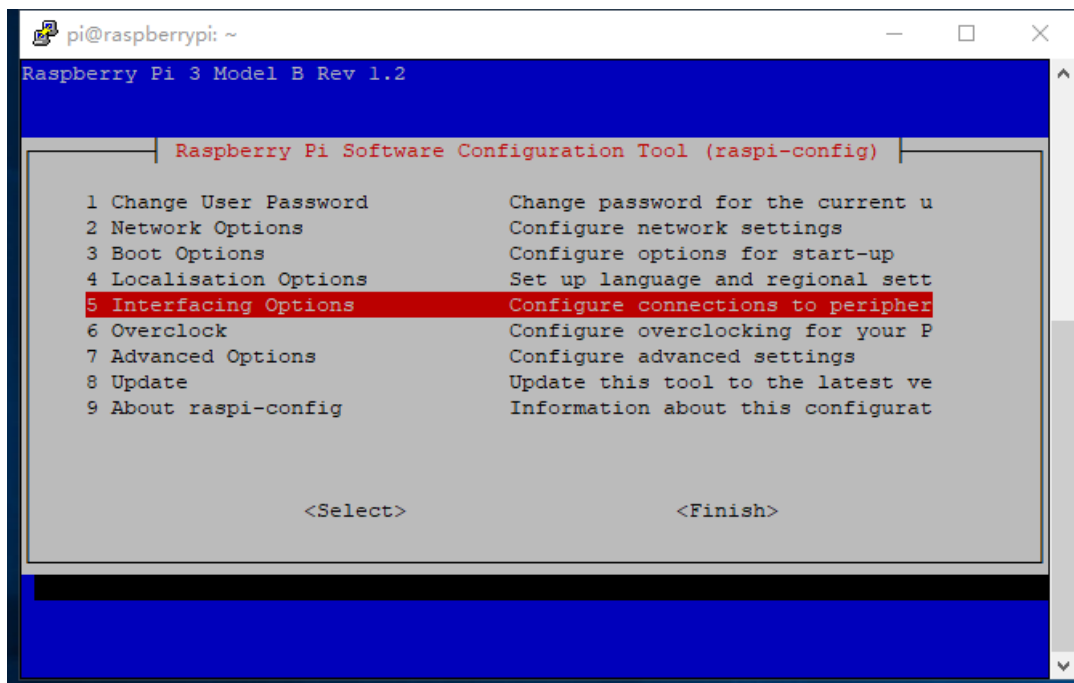

Arrow down to P5 I2C and press "enter" to select.

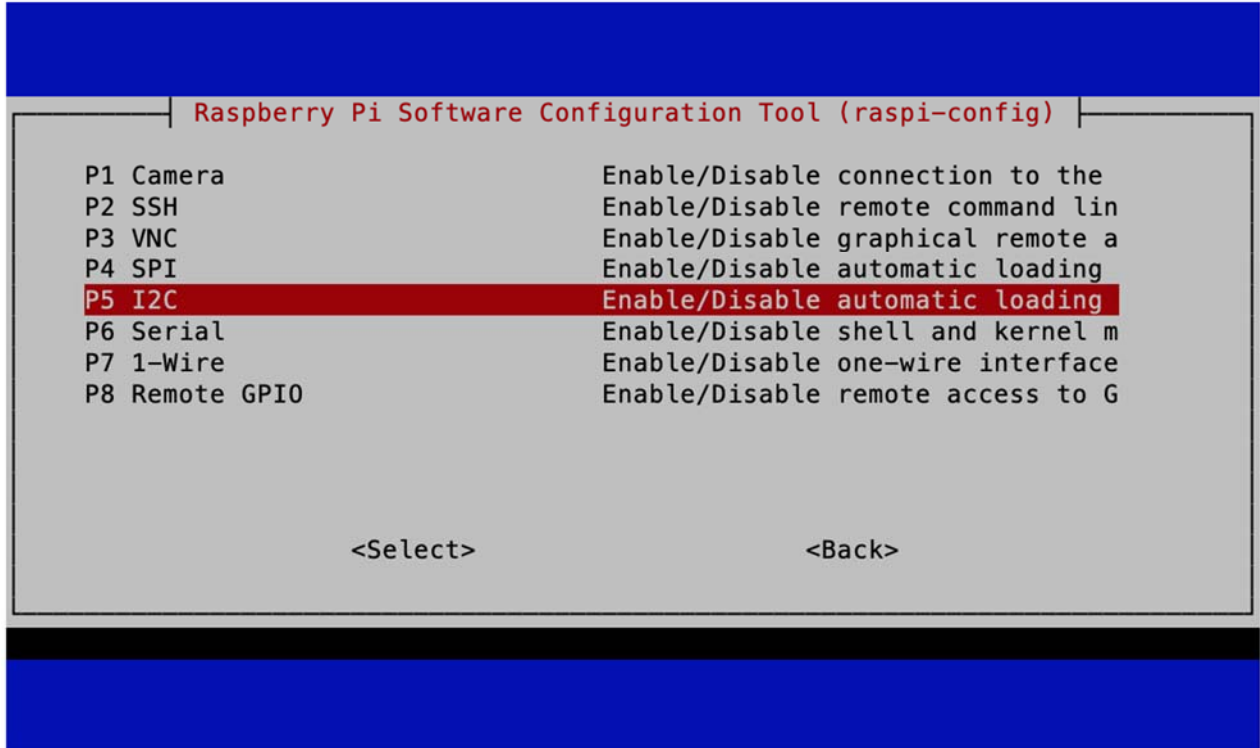

Select "Yes" to enable it.

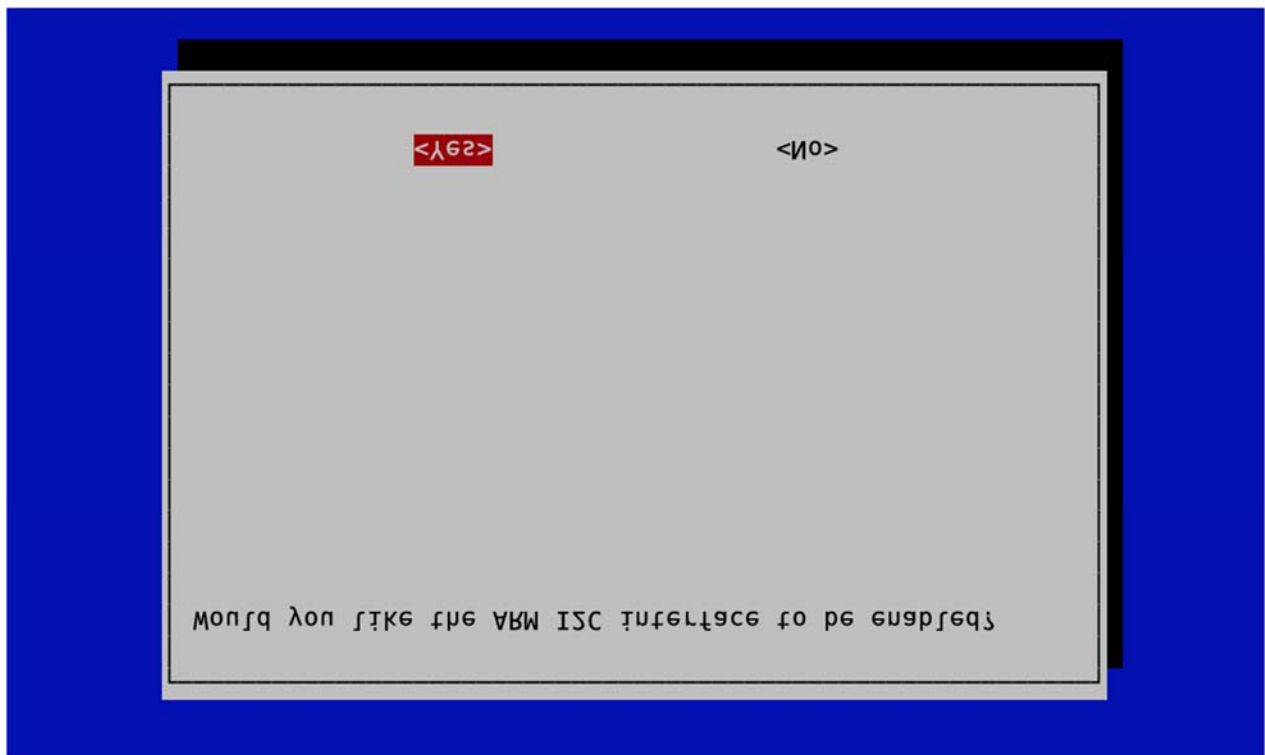

Select "Ok".

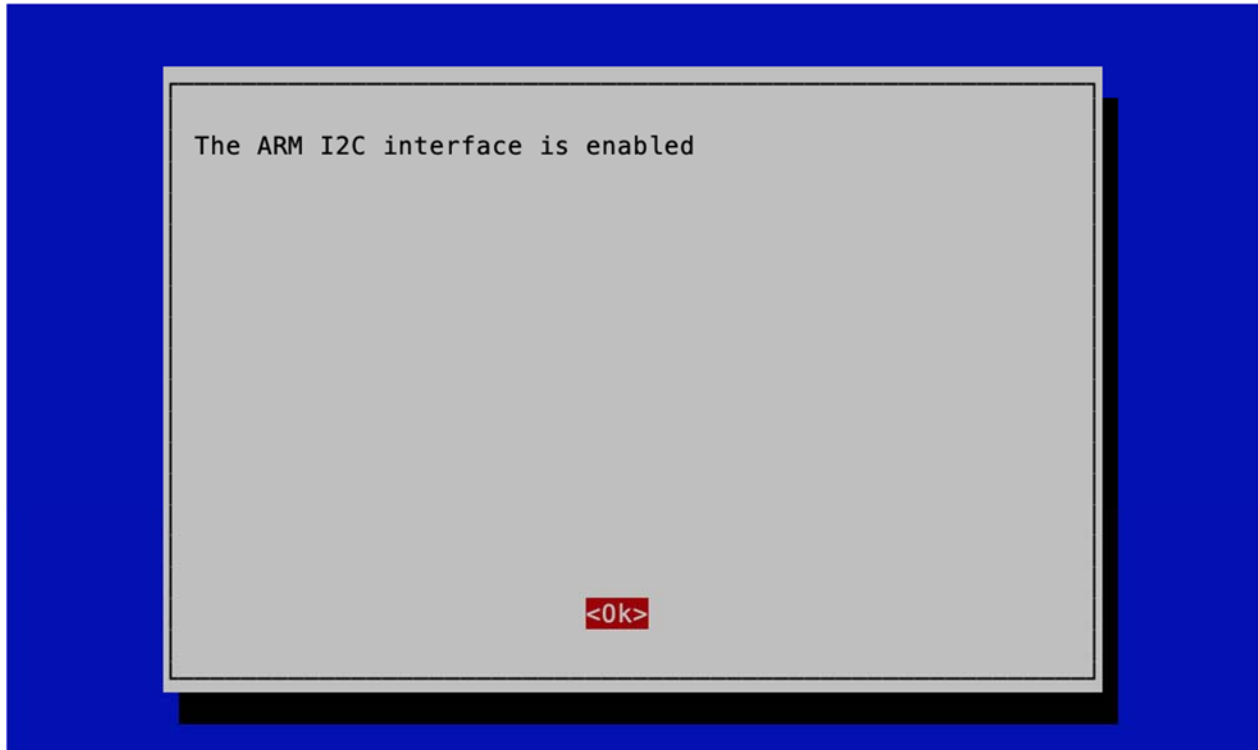

Select "Finish" to save the changes.

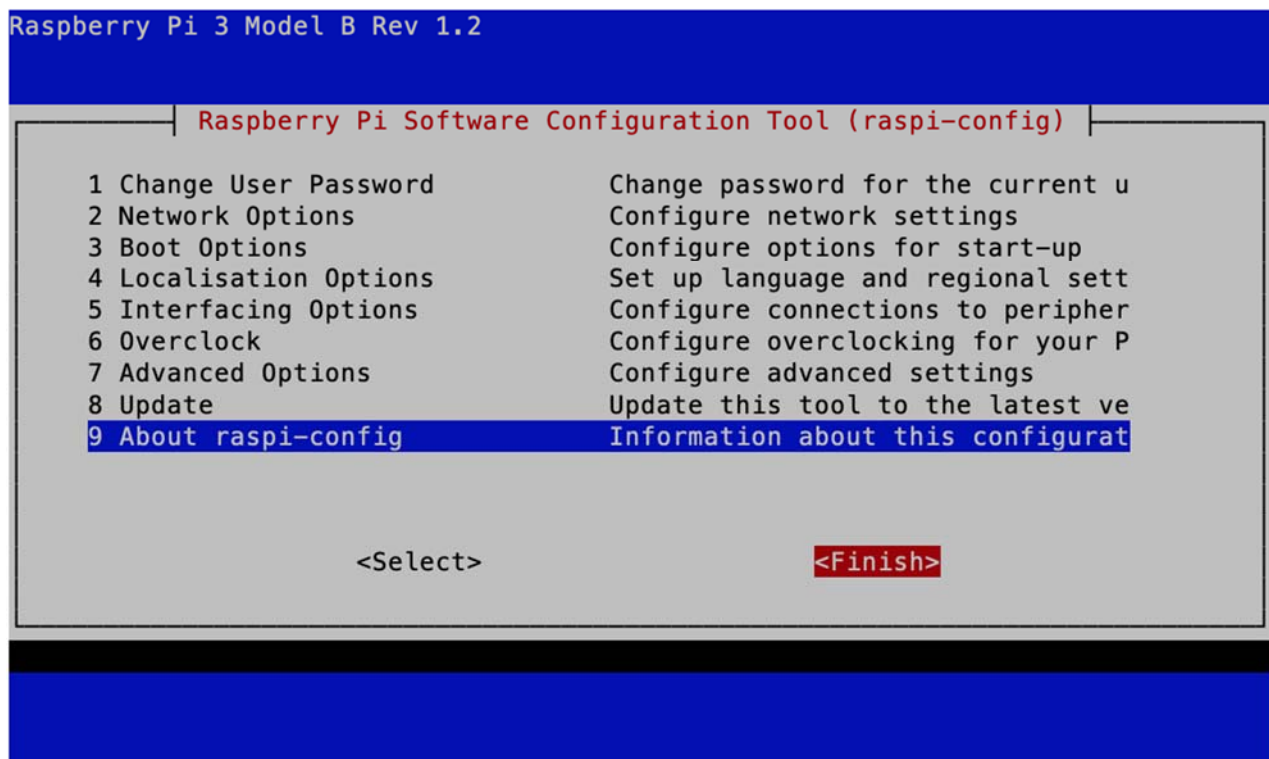

3. One-click installation, quick start, what ever you call, with the single command below.

```
1curl -sL https://github.com/Seeed-Studio/grove.py/raw/master/install.sh |  
sudo bash -s -
```

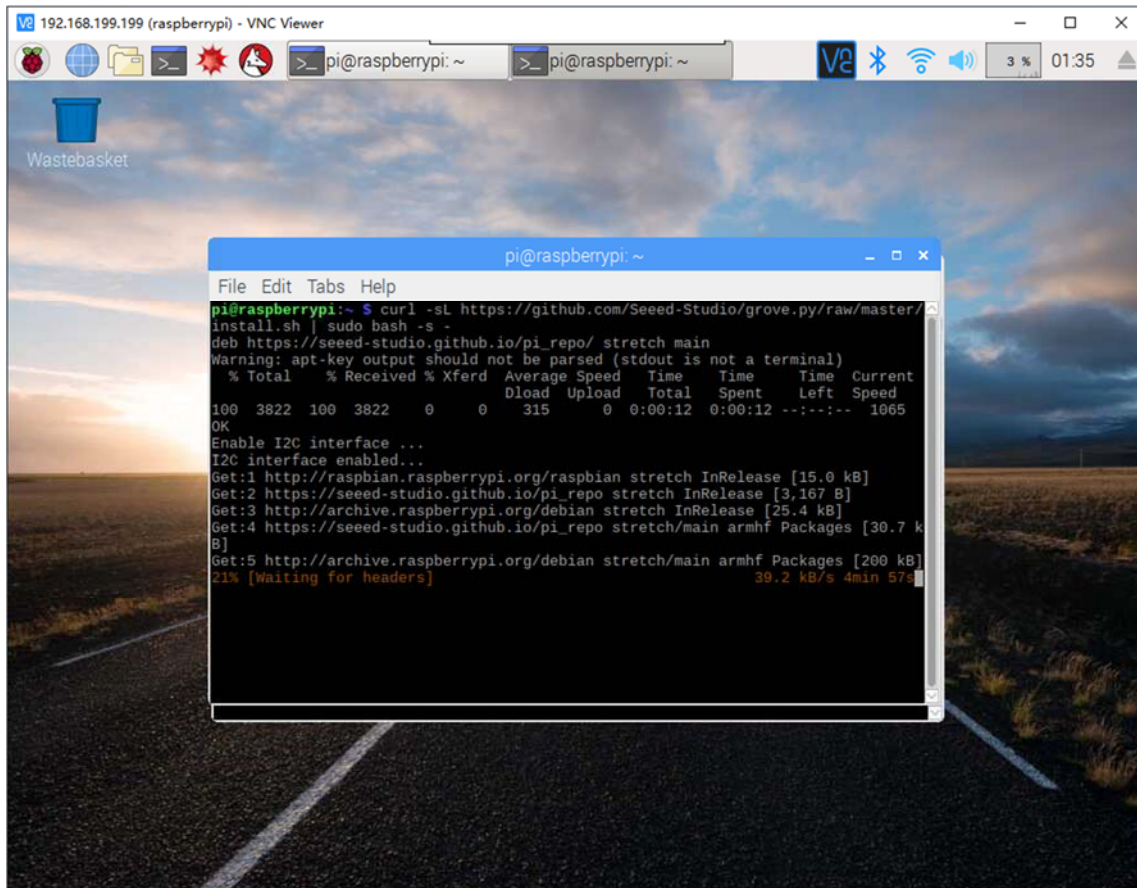

if everything goes well, you will see the following notice.

```
1Successfully installed grove.py-0.6  
2#####  
3Lastest Grove.py from github install complete !!!!!  
4#####
```

4. Besides the one-click installation, you can also **install all the dependencies**).

5. Clone the latest python.py repository library.

```
1git clone https://github.com/Seeed-Studio/grove.py
```

Grove – LED button demo

After all the basic set up of Raspberry Pi, we can now run the LED demo code. Note: You should complete the steps above first in order to continue the following.

Hardware Connection

Step 1: Connect the Grove - Red LED Button to D5 port of Base Hat

Step 2: Insert Base Hat into Raspberry Pi

Step 3: Connect Raspberry Pi to the power source by a micro USB cable.

Upload Code

Step 1: Run the following commands to create a python file

```
1cd grove.py
2nano example.py
```

Step 2: Copy following code in python file

Caution

Please make sure the text editor is under unix format.

```
1#!/usr/bin/env python
2
3import time
4from grove.grove_ryb_led_button import GroveLedButton
5
6def main():
7     ledbtn = GroveLedButton(5)
8
9     while True:
10         ledbtn.led.light(True)
11         time.sleep(1)
12
13         ledbtn.led.light(False)
14         time.sleep(1)
15
16if __name__ == '__main__':
17     main()
```

Step 3 : run the program

```
1sudo chmod +x example.py
```

```
2sudo ./example.py
```

When you single click the LED button, LED will change to "ON" mode, "OFF" if you long press it. If you double click the LED button, the LED will blink.

```
1pi@raspberrypi:~/grove.py $ sudo ./example.py
2turn on LED
3turn on LED
4turn off LED
5turn on LED
6blink LED
7^CTraceback (most recent call last):
8 File "./example.py", line 17, in <module>
9   main()
10 File "./example.py", line 14, in main
11   time.sleep(1)
12KeyboardInterrupt
13pi@raspberrypi:~/grove.py $
```

Explanation of the blink code

In python, as modules are referenced to each other, different modules may have different "main" definition, and there can only be one entry program each time. The selection of the entry program depends on the value of **name**. "if `__name__ == 'main'`" is equal, it means it is the entry of the python emulation.

```
1if __name__ == '__main__':
2    main()
```

Grove Base Kit for Raspberry Pi

Now, are you ready to explore the Grove system? We have designed 8 tutorials for you to start with some basic Grove modules. This section introduces you how modules can be combined and applied in real-life applications.

Prerequisite

To start on the Grove tutorial, you are required the fundamental knowledge of Raspberry Pi and Python programming language. Please make sure you have completed the basic setup tutorial above successfully and finished the LED Blink demo and ensure it is fully working with your Raspberry Pi with the Grove Base Hat.

Learning outcome

- Be able to use Grove Base Hat to build applications with Grove modules.

- Be able to demonstrate each components of Grove Starter Kit and utilise the relevant module to your own projects after this tutorial
- Be able to identify the type of modules include in this Kit and their applications.
- Understand the difference between the analog and digital signal.

Lesson 1: Buzzer

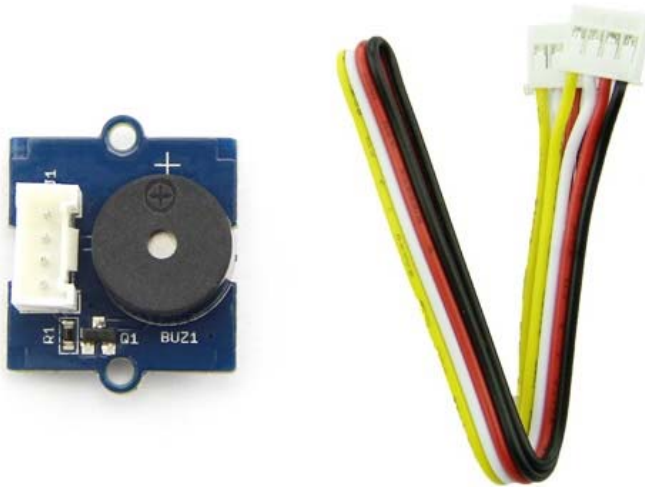

Objective

Using buzzer to generate some noise and also setting specific frequency to produce some tones.

Hardware requirement

Self-prepare

- micro-USB cable
- Raspberry Pi 3 Model B
- Computer

Included in the kit

- Grove Base Hat
- Grove cable
- Grove – Buzzer

Hardware connection

Step 1. Use Grove cable to connect Grove - Buzzer to PWM port of Base Hat and insert the Hat to the Raspberry Pi.

Step 2. Connect Raspberry Pi to the power source by a micro USB cable.

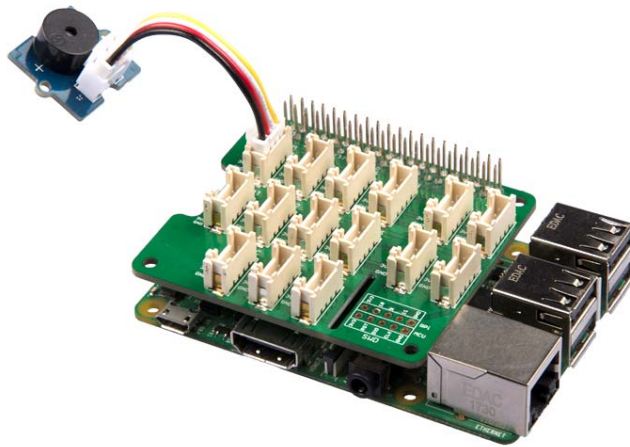

Software programming

Note

Please make sure you have cloned the python.py repository library to your Raspberry Pi.

Step 1: Run the following commands to create a python file

```
1cd grove.py
2nano lesson_1.py
```

Step 2: Copy following code

```
1#!/usr/bin/env python
2import time
3from mraa import getGpioLookup
4from upm import pyupm_buzzer as upmBuzzer
5
6def main():
7    # Grove - Buzzer connected to PWM port
8    buzzer = upmBuzzer.Buzzer(getGpioLookup('GPIO12'))
9
10    CHORDS = [upmBuzzer.BUZZER_DO, upmBuzzer.BUZZER_RE,
11upmBuzzer.BUZZER_MI,
12    upmBuzzer.BUZZER_FA, upmBuzzer.BUZZER_SOL, upmBuzzer.BUZZER_LA,
13    upmBuzzer.BUZZER_SI]
```

```
14 for i in range(0, len(CHORDS)):
15     buzzer.playSound(CHORDS[i], 500000)
16     time.sleep(0.1)
17
18 del buzzer
19 print('application exiting...')
20
21if __name__ == '__main__':
    main()
```

Step 3 : run the program

```
1sudo chmod +x lesson_1.py
2sudo ./lesson_1.py
```

If everything goes well, you should notice the buzzer is making “Do Re Mi Fa So La Si” sound.

Lesson 2: Red LED Button

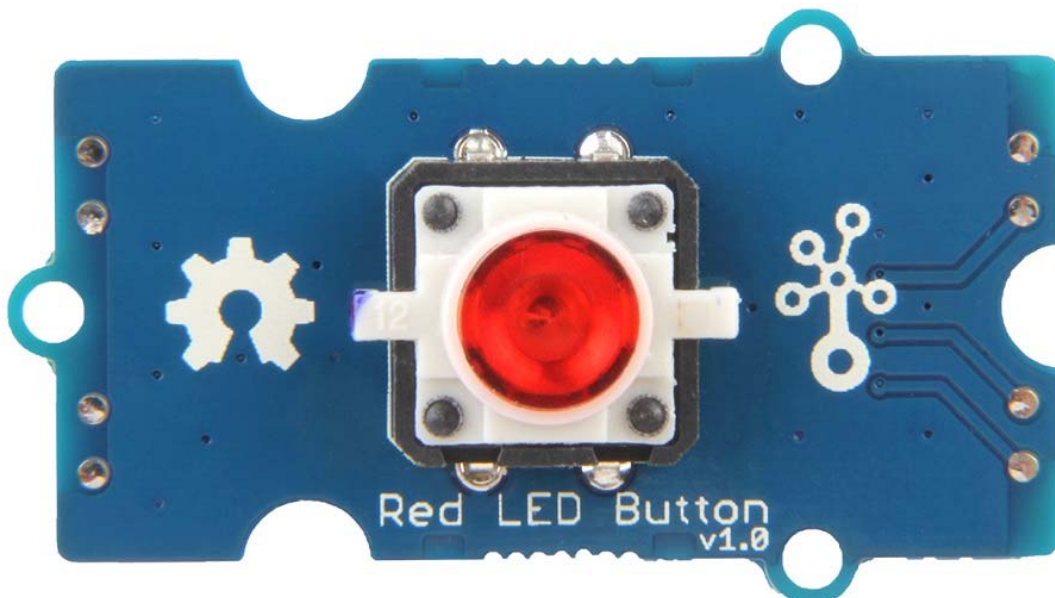

Objective

Use Grove - Red LED Button to control the blinking of LEDs and let Grove - Buzzer to make different sound effects.

Hardware requirement

Self-prepare

- micro-USB cable
- Raspberry Pi 3 Model B
- Computer

Included in the kit

- Grove Base Hat
- Grove cable
- Grove - Red LED Button
- Grove – Buzzer

Hardware connection

Step 1. Use Grove cable to connect Grove - Buzzer to PWM port and Grove - Red LED Button to D5 of Base Hat and insert the Hat to the Raspberry Pi.

Step 2. Connect Raspberry Pi to the power source by a micro USB cable.



Software programming

Note

Please make sure you have cloned the python.py repository library to your Raspberry Pi.

Step 1: Run the following commands to create a python file

```
1cd grove.py
2nano lesson_2.py
```

Step 2: Copy following code

```
1#!/usr/bin/env python
2
3import time
4from mraa import getGpioLookup
5from upm import pyupm_buzzer as upmBuzzer
6
7from grove.button import Button
8from grove.grove_ryb_led_button import GroveLedButton
9
10def main():
11    # Grove - LED Button connected to port D5
12    button = GroveLedButton(5)
13
14    # Grove - Buzzer connected to PWM port
15    buzzer = upmBuzzer.Buzzer(getGpioLookup('GPIO12'))
16
17    def on_event(index, event, tm):
18        if event & Button.EV_SINGLE_CLICK:
19            print('single click')
20            button.led.light(True)
21            buzzer.playSound(upmBuzzer.BUZZER_DO, 500000)
22
23            elif event & Button.EV_LONG_PRESS:
24                print('long press')
25                button.led.light(False)
26                buzzer.playSound(upmBuzzer.BUZZER_DO, 1000000)
27
28    button.on_event = on_event
29
30    while True:
31        time.sleep(1)
32
33if __name__ == '__main__':
34    main()
```

Step 3 : run the program

```
1sudo chmod +x lesson_2.py
2sudo ./lesson_2.py
```

Success

If everything goes well, you will find that when you long press the LED button, the LED will go off and the buzzer will emit a long "Do" sound. However, when you single press it, the LED will light up and the buzzer will make a short "Do" sound.

```
lpi@raspberrypi:~/grove.py $ sudo ./lesson_2.py
2single click
3single click
4single click
5long press
6single click
7long press
8long press
9Traceback (most recent call last):
10 File "./lesson2.py", line 34, in <module>
11   main()
12 File "./lesson2.py", line 31, in main
13   time.sleep(1)
14KeyboardInterrupt
15^Cpi@raspberrypi:~/grove.py $
```

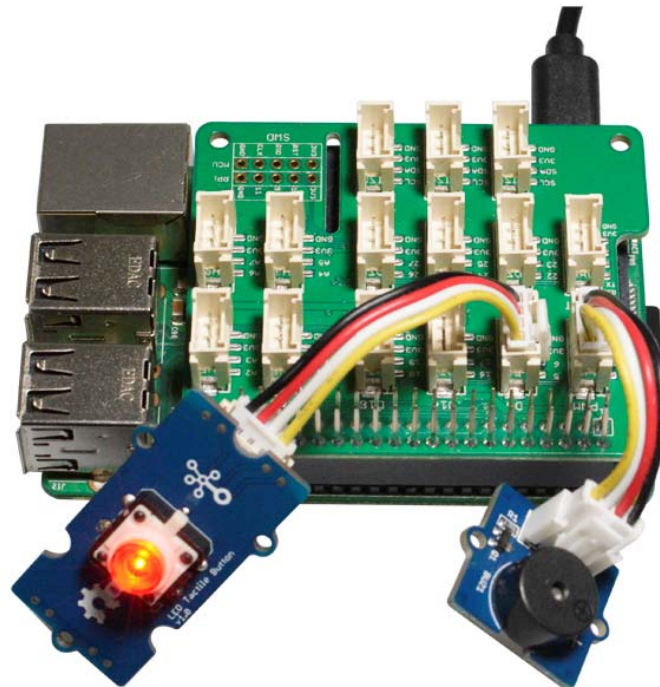

Lesson 3: Light Sensor

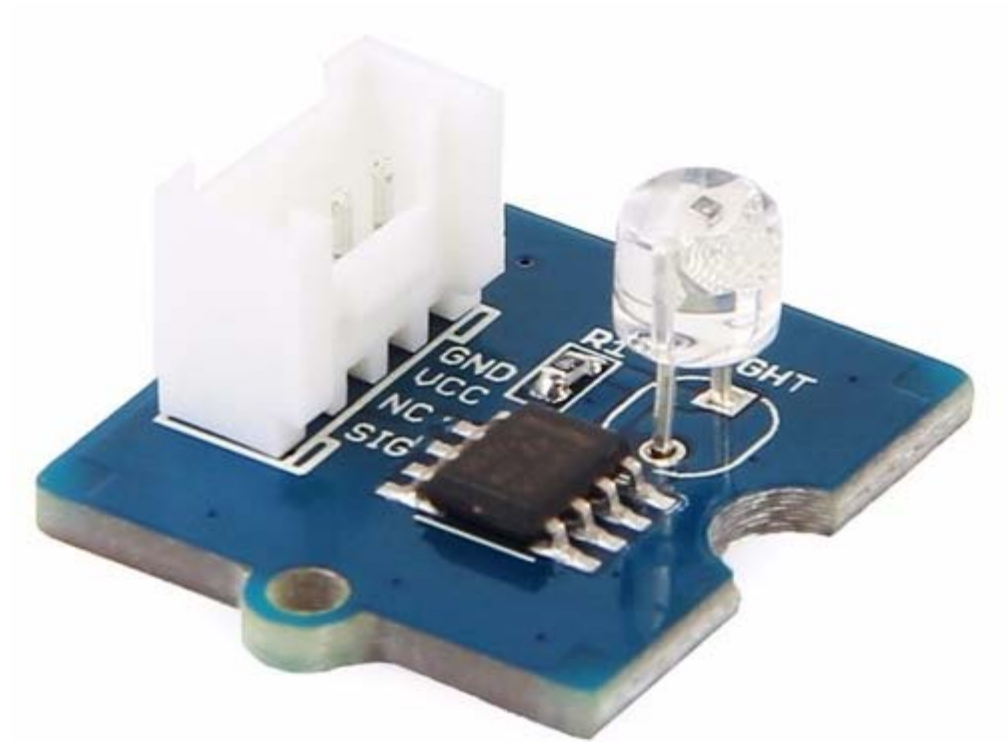

Objective

In this lesson, we will show you how to use Grove - Light Sensor to control Grove - Servo. In this case, servo rotation angle varies with light intensity.

Hardware requirement

Self-prepare

- micro-USB cable
- Raspberry Pi 3 Model B
- Computer

Included in the kit

- Grove Base Hat
- Grove cable
- Grove - Light Sensor
- Grove – Servo

Hardware connection

Step 1 Connect Grove - Light Sensor to port A0, Grove - Servo to PWM port.

Step 2 Insert Base Hat into Raspberry Pi.

Step 3 Connect Raspberry Pi to the power source by a micro USB cable.

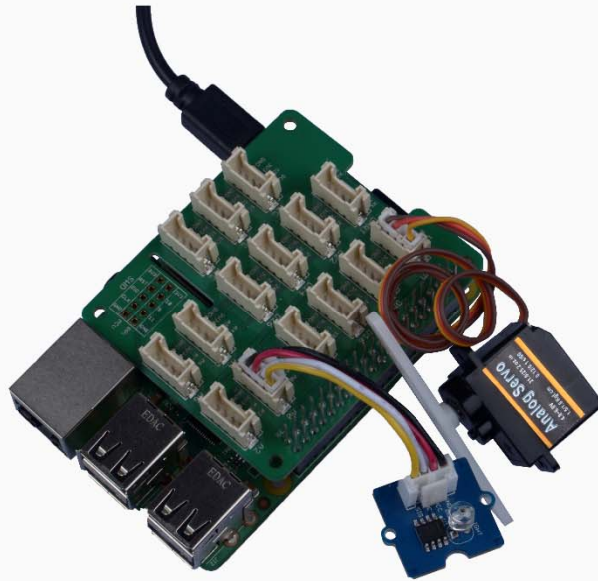

Software programming

Note

Please make sure you have cloned the python.py repository library to your Raspberry Pi.

Step 1: Run the following commands to create a python file

```
1cd grove.py
2nano lesson_3.py
```

Step 2: Copy following code

```
1#!/usr/bin/env python
2
3import time
4
5from grove.grove_servo import GroveServo
6from grove.grove_light_sensor_v1_2 import GroveLightSensor
7
8def main():
```

```
9 # Grove - Servo connected to PWM port
10 servo = GroveServo(12)
11
12 # Grove - Light Sensor connected to port A0
13 sensor = GroveLightSensor(0)
14
15 while True:
16     angle = sensor.light * 180 / 1000
17     print('light value {}, turn to {} degree.'.format(sensor.light,
18angle))
19     servo.setAngle(angle)
20
21     time.sleep(1)
22
23if __name__ == '__main__':
    main()
```

Step 3 : run the program

```
1sudo chmod +x lesson_3.py
2sudo ./lesson_3.py
```

If everything goes well, the change of light intensity will result in different rotation angle of servo.

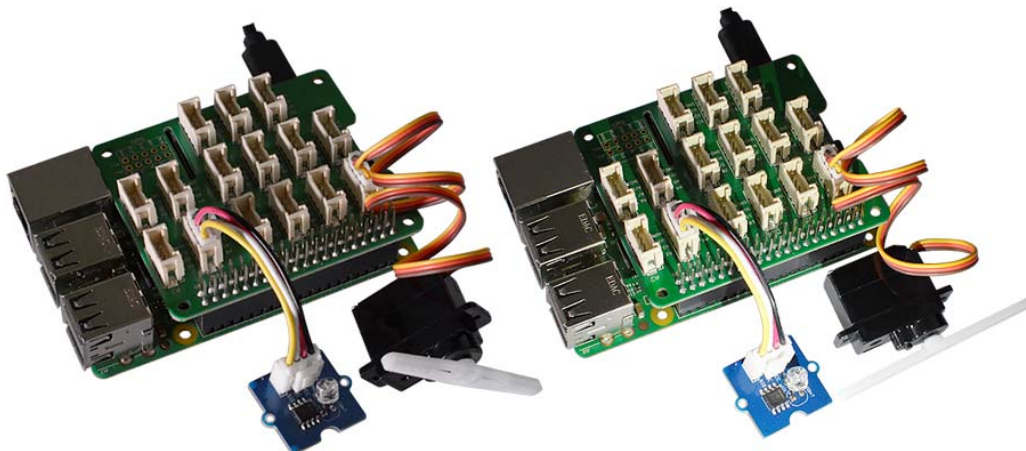

```
1pi@raspberrypi:~/grove.py $ sudo ./lesson_3.py
2light value 300, turn to 113 degree.
3light value 80, turn to 80 degree.
4light value 166, turn to 165 degree.
5light value 498, turn to 132 degree.
6light value 601, turn to 60 degree.
7light value 200, turn to 21 degree.
8light value 459, turn to 99 degree.
9light value 172, turn to 173 degree.
10light value 319, turn to 138 degree.
11^CTraceback (most recent call last):
12 File "./lesson3.py", line 23, in <module>
13   main()
14 File "./lesson3.py", line 20, in main
15   time.sleep(1)
16KeyboardInterrupt
17pi@raspberrypi:~/grove.py $
```

Lesson 4: Motion Sensor & Relay



Objective

Use Grove - mini PIR motion sensor to detect the motion, light on if people come.

Hardware requirement

Self-prepare

- micro-USB cable
- Raspberry Pi 3 Model B
- Computer

Included in the kit

- Grove Base Hat
- Grove cable
- Grove - mini PIR motion sensor
- Grove - Relay

Hardware Connection

Step 1 Connect Grove - mini PIR motion sensor to port D5, Grove - Relay to port D16 of Base Hat.

Step 2 Insert Base Hat into Raspberry Pi

Step 3 Connect Raspberry Pi to the power source by a micro USB cable.



Software programming

Note

Please make sure you have cloned the python.py repository library to your Raspberry Pi.

Step 1: Run the following commands to create a python file

```
1cd grove.py
2nano lesson_4.py
```

Step 2: Copy following code

```
1#!/usr/bin/env python
2
3import time
4
5from grove.grove_mini_pir_motion_sensor import GroveMiniPIRMotionSensor
6from grove.grove_relay import GroveRelay
7
8def main():
```

```

 9 # Grove - mini PIR motion sensor connected to port D5
10 sensor = GroveMiniPIRMotionSensor(5)
11
12 # Grove - Relay connected to port D16
13 relay = GroveRelay(16)
14
15 def on_detect():
16     print('motion detected')
17
18     relay.on()
19     print('relay on')
20
21     time.sleep(1)
22
23     relay.off()
24     print('relay off')
25
26 sensor.on_detect = on_detect
27
28 while True:
29     time.sleep(1)
30
31 if __name__ == '__main__':
32     main()

```

Step 3 : run the program

```

1sudo chmod +x lesson_4.py
2sudo ./lesson_4.py

```

If everything goes well, you should see the relay on/off once it detect a motion.

```

1pi@raspberrypi:~/grove.py $ sudo ./lesson_4.py
2motion detected
3relay on
4relay off
5motion detected
6relay on
7relay off
8^CTraceback (most recent call last):
 9 File "./lesson_4.py", line 33, in <module>
10     main()
11 File "./lesson_4.py", line 30, in main
12     time.sleep(1)
13KeyboardInterrupt
14pi@raspberrypi:~/grove.py $

```

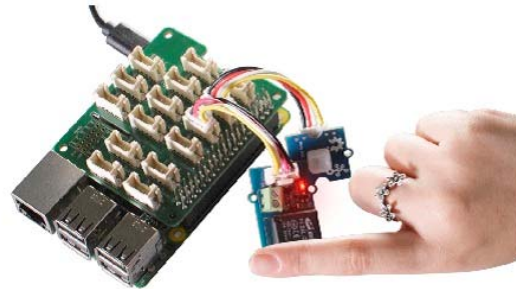
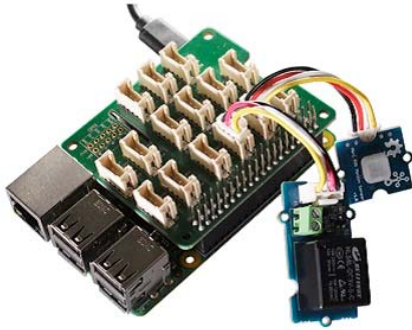

Lesson 5: Ultrasonic Sensor & Relay



Objective

In this lesson, we use Grove - Ultrasonic Ranger to detect the distance, once someone getting closer, the light on the Grove - Relay should be "ON".

Hardware requirement

Self-prepare

- micro-USB cable
- Raspberry Pi 3 Model B
- Computer

Included in the kit

- Grove Base Hat
- Grove cable

- Grove - Ultrasonic Ranger
- Grove - Relay

Hardware connection

Step 1 Connect Grove - Ultrasonic Ranger to port D5, Grove - Relay to port D16 of Base Hat.

Step 2 Insert Base Hat into Raspberry Pi

Step 3 Connect Raspberry Pi to the power source by a micro USB cable.



Software programming

Note

Please make sure you have cloned the python.py repository library to your Raspberry Pi.

Step 1: Run the following commands to create a python file

```
1cd grove.py
2nano lesson_5.py
```

Step 2: Copy following code

```
1#!/usr/bin/env python
2
3import time
4
5from grove.grove_relay import GroveRelay
6from grove.grove_ultrasonic_ranger import GroveUltrasonicRanger
7
8def main():
9    # Grove - Ultrasonic Ranger connected to port D5
10    sensor = GroveUltrasonicRanger(5)
11
```

```

12 # Grove - Relay connected to port D16
13 relay = GroveRelay(16)
14
15 while True:
16     distance = sensor.get_distance()
17     print('{} cm'.format(distance))
18
19     if distance < 20:
20         relay.on()
21         print('relay on')
22
23         time.sleep(1)
24
25         relay.off()
26         print('relay off')
27
28         continue
29
30     time.sleep(1)
31
32 if __name__ == '__main__':
33     main()

```

Step 3 : run the program

```

1sudo chmod +x lesson_5.py
2sudo ./lesson_5.py

```

If everything goes well, the change of light intensity will result in different rotation angle of servo.

```

1pi@raspberrypi:~/grove.py $ sudo ./lesson_5.py
2253.722585481 cm
3253.739028141 cm
4252.896341784 cm
51.20442489098 cm
6relay on
7relay off
84.51762100746 cm
9relay on
10relay off
11253.985668051 cm
12^CTraceback (most recent call last):
13 File "./lesson_5.py", line 34, in <module>
14     main()
15 File "./lesson_5.py", line 31, in main
16     time.sleep(1)
17KeyboardInterrupt
18pi@raspberrypi:~/grove.py $

```



Now, compare the result from lesson four and lesson five, are you able to list the advantages and disadvantages of Grove - mini PIR motion sensor and Grove Ultrasonic Ranger?

Lesson 6: LCD



Objective

Uses Grove - 16*2 LCD screen to display "Hello World".

Hardware requirement

Self-prepare

- micro-USB cable
- Raspberry Pi 3 Model B
- Computer

Included in the kit

- Grove Base Hat
- Grove cable
- Grove - 16*2 LCD

Hardware connection

Step 1 Connect Grove - 16*2 LCD to I2C port of Base Hat.

Step 2 Insert Base Hat into Raspberry Pi.

Step 3 Connect Raspberry Pi to the power source by a micro USB cable.



Software programming

Note

Please make sure you have cloned the python.py repository library to your Raspberry Pi.

Step 1: Run the following commands to create a python file

```
1cd grove.py
2nano lesson_6.py
```

Step 2: Copy following code

```
1#!/usr/bin/env python
2
3import time
4
5from grove.display.jhd1802 import JHD1802
6
7def main():
```

```

8   # Grove - 16x2 LCD(White on Blue) connected to I2C port
9   lcd = JHD1802()
10
11  lcd.setCursor(0, 0)
12  lcd.write('hello, world!!!!')
13
14  print('application exiting...')
15
16if __name__ == '__main__':
17    main()

```

Step 3 : run the program

```

1sudo chmod +x lesson_6.py
2sudo ./lesson_6.py

```

You should see “hello, world!!!” displayed on the LCD screen.

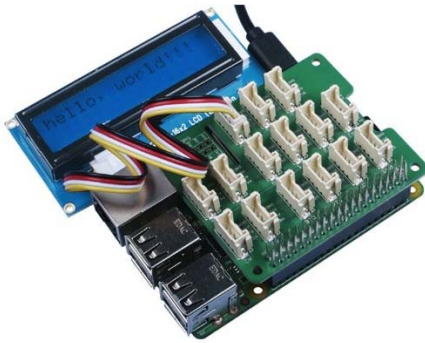

If you want to use the Grove - 16*2 LCD screen to display some other characters, you can simply change ++ lcd.write('hello, world!!!!')++ in the code.

Lesson 7: LCD & Temperature and Humidity Sensor



Objective

Uses Grove - 16*2 LCD screen to display data(temperature and humidity) from Grove - Temperature and Humidity Sensor

Hardware requirement

Self-prepare

- micro-USB cable
- Raspberry Pi 3 Model B
- Computer

Included in the kit

- Grove Base Hat
- Grove cable
- Grove - 16*2 LCD
- Grove - Temperature and Humidity Sensor

Hardware connection

Step 1 Connect Grove - 16*2 LCD to I2C port, Grove - Temperature and Humidity Sensor to port D5.

Step 2 Insert Base Hat into Raspberry Pi.

Step 3 Connect Raspberry Pi to the power source by a micro USB cable.



Software programming

Note

Please make sure you have cloned the python.py repository library to your Raspberry Pi.

Step 1: Run the following commands to create a python file

```
1cd grove.py
2nano lesson_7.py
```

Step 2: Copy following code

```
1#!/usr/bin/env python
2
3import time
4
5from grove.grove_temperature_humidity_sensor import DHT
6from grove.display.jhd1802 import JHD1802
7
8def main():
9    # Grove - 16x2 LCD(White on Blue) connected to I2C port
10    lcd = JHD1802()
11
12    # Grove - Temperature&Humidity Sensor connected to port D5
13    sensor = DHT('11', 5)
14
15    while True:
16        humi, temp = sensor.read()
17        print('temperature {}C, humidity {}'.format(temp, humi))
18
19        lcd.setCursor(0, 0)
20        lcd.write('temperature: {0:2}C'.format(temp))
21
22        lcd.setCursor(1, 0)
23        lcd.write('humidity: {0:5}%'.format(humi))
24
25        time.sleep(1)
26
27if __name__ == '__main__':
28    main()
```

Step 3 : run the program

```
1sudo chmod +x lesson_7.py
2sudo ./lesson_7.py
```

If everthing goes well, you should see current temperature and humidity values display on the LCD screen

```
lpi@raspberrypi:~/grove.py $ sudo ./lesson_7.py
2temperature 23C, humidity 16%
3temperature 22C, humidity 17%
4temperature 22C, humidity 17%
```

```
5^CTraceback (most recent call last):
6 File "./lesson_7.py", line 28, in <module>
7   main()
8 File "./lesson_7.py", line 25, in main
9   time.sleep(1)
10KeyboardInterrupt
11pi@raspberrypi:~/grove.py $
```

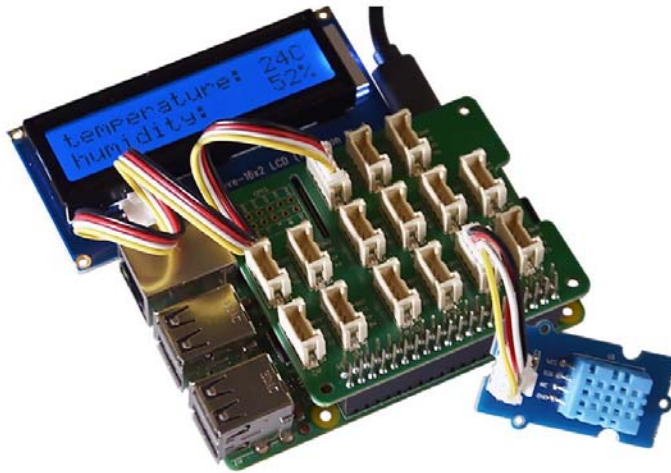

Lesson 8: LCD & Moisture Sensor & Buzzer

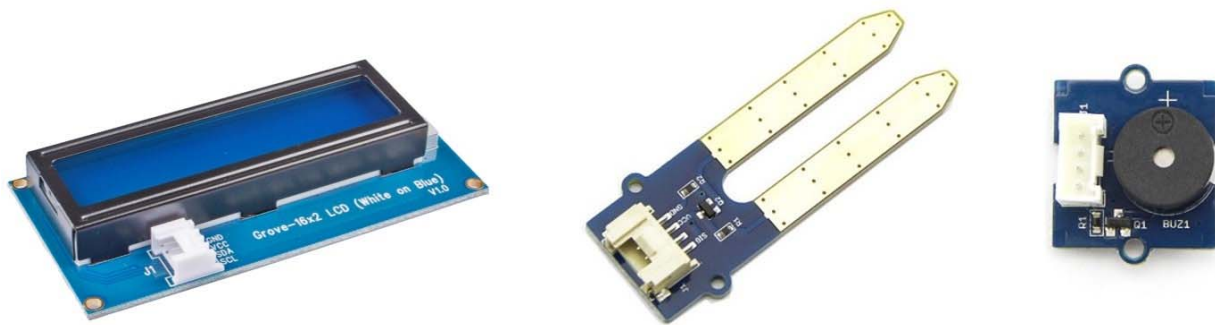

Objective

Use Grove - 16 * 2 LCD to display the current moisture level. When the moisture status is "wet", the Grove - Buzzer should alert you.

Hardware requirement

Self-prepare

- micro-USB cable
- Raspberry Pi 3 Model B
- Computer

Included in the kit

- Grove Base Hat
- Grove cable
- Grove - 16*2 LCD
- Grove - Moisture Sensor
- Grove - Buzzer

Hardware Connection

Step 1 Connect Grove - 16*2 LCD to I2C port, Grove - Moisture Sensor to A0 port and Grove - Buzzer to PWM port of Grove Base Hat.

Step 2 Insert Base Hat to Raspberry Pi.

Step 3 Use micro USB to connect Raspberry Pi with PC.

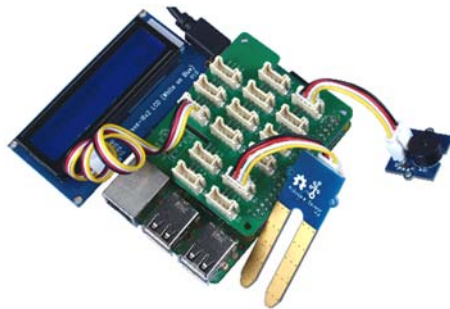

Software programming

Note

Please make sure you have cloned the python.py repository library to your Raspberry Pi.

Step 1: Run the following commands to create a python file

```
1cd grove.py
2nano lesson_8.py
```

Step 2 : Copy following code

```
1#!/usr/bin/env python
2
3import time
4from mraa import getGpioLookup
5from upm import pyupm_buzzer as upmBuzzer
6
7from grove.grove_moisture_sensor import GroveMoistureSensor
8from grove.lcd.sh1107g import JHD1802
9
10def main():
11     # Grove - 16x2 LCD(White on Blue) connected to I2C port
12     lcd = JHD1802()
13
14     # Grove - Moisture Sensor connected to port A0
15     sensor = GroveMoistureSensor(0)
16
17     # Grove - Buzzer connected to port PWM
18     buzzer = upmBuzzer.Buzzer(getGpioLookup('GPIO12'))
19
20     while True:
21         mois = sensor.moisture
22         if 0 <= mois and mois < 300:
23             level = 'dry'
24         elif 300 <= mois and mois < 600:
25             level = 'moist'
26         else:
27             level = 'wet'
28             buzzer.playSound(upmBuzzer.BUZZER_DO, 200000)
29
30         print('moisture: {}, {}'.format(mois, level))
31
32         lcd.setCursor(0, 0)
33         lcd.write('moisture: {0:>6}'.format(mois))
34
35         lcd.setCursor(1, 0)
36         lcd.write('{0:>16}'.format(level))
37
38         time.sleep(1)
39
40if __name__ == '__main__':
41     main()
```

Step 3 : run the program

```
1sudo chmod +x lesson_8.py
2sudo ./lesson_8.py
```

If everything goes well, you will be able to see the moisture level on the LCD screen. Buzzer is used to alert people once the moisture level reach "wet".

```
1pi@raspberrypi:~/grove.py $ sudo ./lesson_8.py
2moisture: 0, dry
3moisture: 0, dry
4moisture: 396, moist
5moisture: 398, moist
6moisture: 407, wet
7moisture: 418, wet
8^CTraceback (most recent call last):
9  File "./lesson_8.py", line 41, in <module>
10     main()
11  File "./lesson_8.py", line 38, in main
12     time.sleep(1)
13KeyboardInterrupt
14pi@raspberrypi:~/grove.py $
```

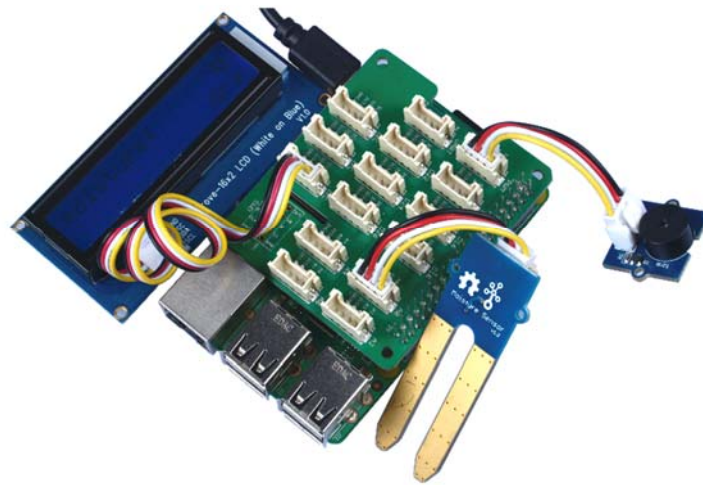

TECH SUPPORT

Please do not hesitate to submit the issue into our [forum](#) or drop mail to techsupport@seeed.cc.



http://wiki.seeedstudio.com/Grove_Base_Kit_for_Raspberry_Pi/<https://www.seeedstudio.com/Grove-Base-Kit-for-Raspberry-Pi-p-2945.html//4-12-19>