

CyberPower[®]

User's Manual

OLS1000EA
OLS1500EA
OLS2000EA
OLS3000EA

TABLE OF CONTENTS

IMPORTANT SAFETY INSTRUCTIONS	1
UNPACKING	3
INSTALLING YOUR UPS SYSTEM	4
SYSTEM BLOCK DIAGRAM.....	4
HARDWARE INSTALLATION GUIDE	4
OVERVIEW	6
POWER MODULE FRONT/REAR PANEL DESCRIPTION	6
BATTERY MODULE FRONT/REAR PANEL DESCRIPTION.....	10
UPS SYSTEM STARTUP	11
USING THE UPS SYSTEM	12
LCD PANEL	12
ICON DESCRIPTION	13
FUNCTION TREE	14
MAIN MENU: FUNCTION SELECT	15
EVENT CODE LIST	23
LCD WORD INDEX	25
TROUBLESHOOTING	27
MAINTENANCE	29
TECHNICAL SPECIFICATIONS	30
APPENDIX - LCD WORD COMPARISON TABLE	32

IMPORTANT SAFETY INSTRUCTIONS

This manual contains important instructions. Please read and follow all instructions carefully during installation and operation of the unit. Read this manual thoroughly before attempting to unpack, install, or operate the UPS.

CAUTION! The UPS must be connected to a grounded AC power outlet with fuse or circuit breaker protection. DO NOT plug the UPS into an outlet that is not grounded. If you need to power-drain this equipment, turn off and unplug the unit.

CAUTION! The battery can power hazardous components inside the unit, even when the AC input power is disconnected.

CAUTION! The UPS should be placed near the connected equipment and easily accessible.

CAUTION! To prevent the risk of fire or electric shock, install in a temperature and humidity controlled indoor area, free of conductive contaminants. (Please see specifications for acceptable temperature and humidity range).

CAUTION! (No User Serviceable Parts): Risk of electric shock, do not remove cover. No user serviceable parts inside. Refer servicing to qualified service personnel.

CAUTION! (Non-Isolated Battery Supply): Risk of electric shock, battery circuit is not isolated from AC power source; hazardous voltage may exist between battery terminals and ground. Test before touching.

CAUTION! To reduce the risk of fire, connect the UPS to a branch circuit with 10 amperes (1000 / 1500 / 2000) / 16 amperes (3000) maximum over-current protection in accordance to CE requirement.

CAUTION! The AC outlet where the UPS is connected should be close to the unit and easily accessible.

CAUTION! Please use only VDE-tested, CE-marked mains cable, (e.g. the mains cable of your equipment), to connect the UPS to the AC outlet.

CAUTION! Please use only VDE-tested, CE-marked power cables to connect any equipment to the UPS.

CAUTION! When installing the equipment, ensure that the sum of the leakage current of the UPS and the connected equipment does not exceed 3.5mA.

CAUTION! The 1000 / 1500 / 2000 / 3000 / Battery module models are only qualified maintenance personnel may carry out installations.

CAUTION! Do not unplug the unit from AC Power during operation, as this will invalidate the protective ground insulation.

CAUTION! To avoid electric shock, turn off and unplug the unit before installing the input/output power cord with a ground wire. Connect the ground wire prior to connecting the line wires!

CAUTION! Do not use an improper size power cord as it may cause damage to your equipment and cause fire hazards.

CAUTION! Wiring must be performed by qualified personnel.

IMPORTANT SAFETY INSTRUCTIONS

CAUTION! DO NOT USE FOR MEDICAL OR LIFE SUPPORT EQUIPMENT! Under no circumstances this unit should be used for medical applications involving life support equipment and/or patient care.

CAUTION! DO NOT USE WITH OR NEAR AQUARIUMS! To reduce the risk of fire, do not use with or near aquariums. Condensation from the aquarium can come in contact with metal electrical contacts and cause the machine to short out.

CAUTION! Do not dispose of batteries in fire as the battery may explode.

CAUTION! Do not open or mutilate the battery, released electrolyte is harmful to the skin and eyes.

CAUTION! A battery can present a risk of electric shock and high short circuit current. The following precaution should be observed when working on batteries

- Remove watches, rings or other metal objects.
- Use tools with insulated handles.

CAUTION! The unit has a dangerous amount of voltage. When the UPS indicators is on, the units may continue to supply power thus the unit's outlets may have a dangerous amount of voltage even when it's not plugged in to the wall outlet.

CAUTION! Make sure everything is turned off and disconnected completely before conducting any maintenance, repairs or shipment.

CAUTION! Connect the Protection Earth (PE) safety conductor before any other cables are connected.

WARNING! (Fuses): To reduce the risk of fire, replace only with the same type and rating of fuse.

DO NOT INSTALL THE UPS WHERE IT WOULD BE EXPOSED TO DIRECT SUNLIGHT OR NEAR A STRONG HEAT SOURCE!

DO NOT BLOCK OFF VENTILATION OPENINGS AROUND THE HOUSING!

DO NOT CONNECT DOMESTIC APPLIANCES SUCH AS HAIR DRYERS TO UPS OUTPUT SOCKETS!

SERVICING OF BATTERIES SHOULD BE PERFORMED OR SUPERVISED BY PERSONNEL KNOWLEDGE OF BATTERIES AND THE REQUIRED PRECAUTIONS. KEEP UNAUTHORIZED PERSONNEL AWAY FROM BATTERIES!

UNPACKING

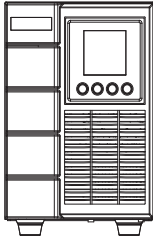

UPS



User's manual



Input power cord



Output power cord(s)
*for selected models only



USB communication cable

PowerPanel® Business software is available on our website.
Please visit www.cyberpower.com and go to the Software Section for free download.

INSTALLING YOUR UPS SYSTEM

SYSTEM BLOCK DIAGRAM

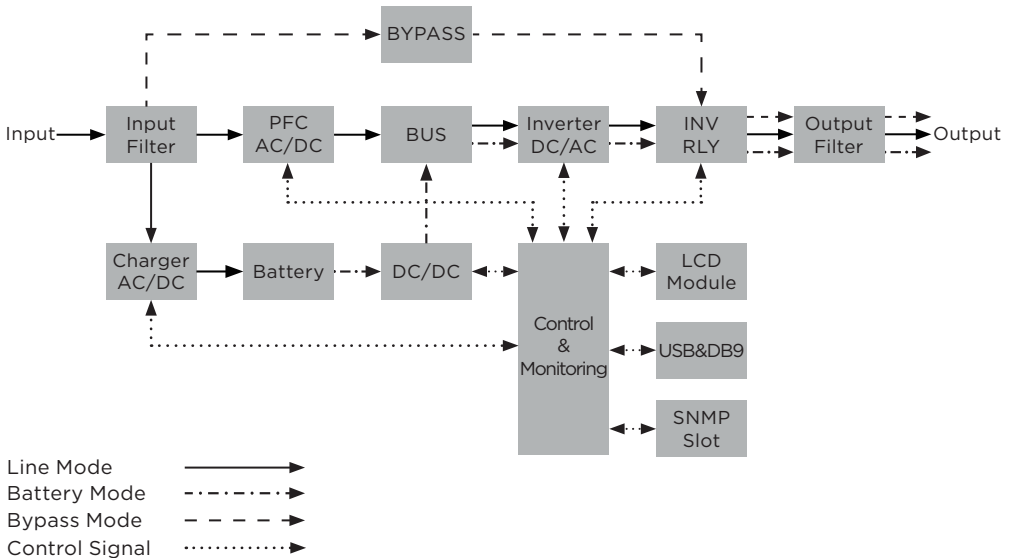

HARDWARE INSTALLATION GUIDE

1. Battery charge loss may occur during shipping and storage. Before using the UPS, it's strongly recommended to charge batteries for five hours to ensure the batteries' maximum charge capacity. To recharge the batteries, simply plug the UPS into an AC outlet.
2. When using the included software, connect either the serial or the USB cable between the computer and the corresponding port on the UPS. Note: If the USB port is used, the serial port will be disabled. They cannot be used simultaneously.
3. Connect your computer, monitor, and any externally-powered data storage device (Hard drive, Tape drive, etc.) into the outlets only when the UPS is off and unplugged. DO NOT plug a laser printer, copier, space heater, vacuum, paper shredder or other large electrical device into the UPS. The power demands of these devices will overload and possibly damage the unit.
4. To protect a fax machine, telephone, modem line or network cable, connect the telephone or network cable from the wall jack outlet to the jack marked "IN" on the UPS and connect a telephone cable or network cable from the jack marked "OUT" on the UPS to the modem, computer, telephone, fax machine, or network device.
5. Press the ON/OFF switch to turn the UPS on. If an overload is detected, an audible alarm will sound and the UPS will continuously emit one beep per second. For resetting the unit, unplug some equipment from the outlets. Make sure your equipment carries a load current within the unit's safe range, (refer to the technical specifications).
6. This UPS is equipped with an auto-charge feature. When the UPS is connected to an AC outlet, the battery will automatically charge, even when the unit is switched off.

INSTALLING YOUR UPS SYSTEM

7. To maintain an optimal battery charge, leave the UPS connected to AC electrical service at all times.
8. Before storing the UPS for an extended period of time, turn the unit OFF. Then cover it and store it with the batteries fully charged. Recharge the batteries every three months to ensure good battery capacity and long battery life. Maintaining a good battery charge will help prevent possible damage to the unit from battery leakage.
9. The UPS has one USB port (default) and one Serial port that allow connection and communication between the UPS and any attached computer running the PowerPanel® Business Edition Agent software. The UPS can control the computer's shutdown during a power outage through the connection while the computer can monitor the UPS and alter various programmable parameters. Note: Only one communication port can be used at a time. The port not in use will automatically become disabled or the serial port will be disabled if both ports are attached.
10. EPO (Emergency Power Off) / ROO (Remote on/off) Port: EPO/ROO ports allow administrators the capability to connect the UPS unit to customer-supplied EPO/ROO switches. If EPO is enabled, these installations give operators a single access point to immediately power-off all equipment connected to the UPS during an emergency. If ROO is enabled, these installations give operators an access point to turn on/off UPS remotely.
11. To avoid electric shock, turn the unit OFF and disconnect the unit from utility power before hardwiring the UPS (in/out power cord). The in/out power cord MUST be grounded.

OVERVIEW

POWER MODULE FRONT/REAR PANEL DESCRIPTION

OLS1000EA

Front

Rear

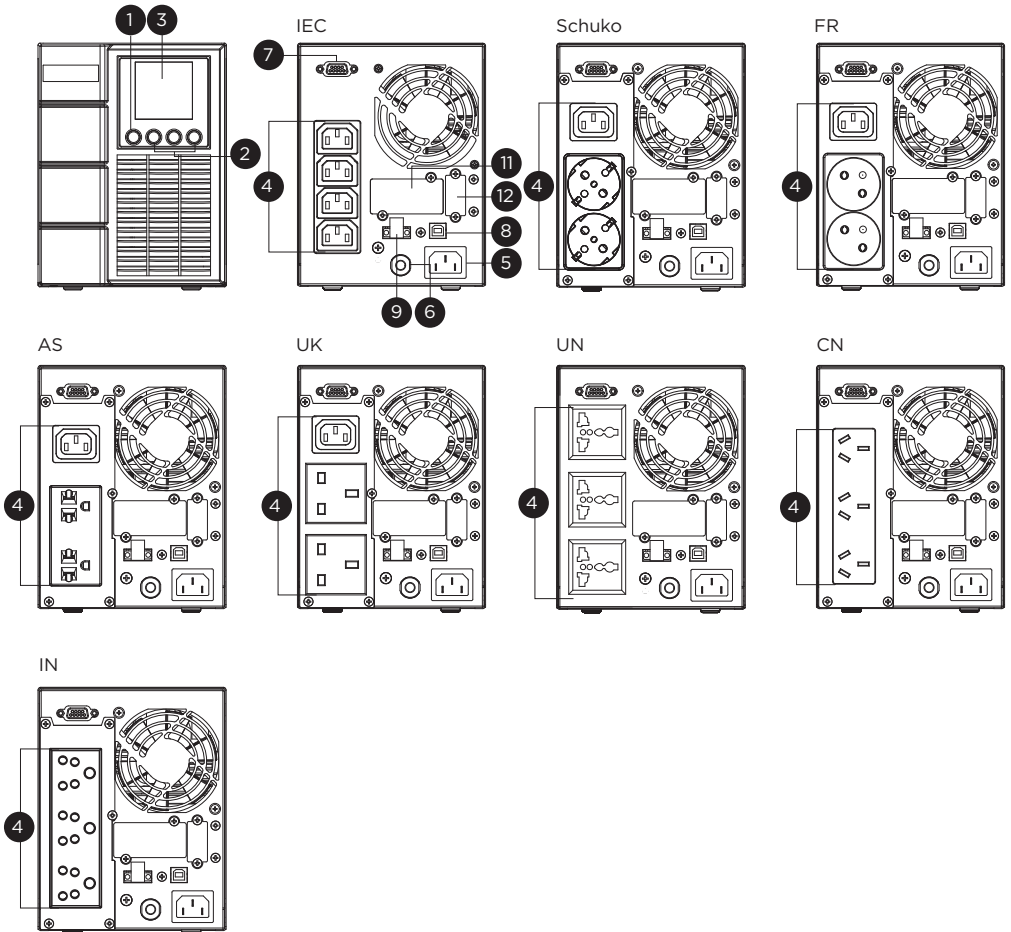

OVERVIEW

POWER MODULE FRONT/REAR PANEL DESCRIPTION

OLS1500EA/OLS2000EA

Front

Rear

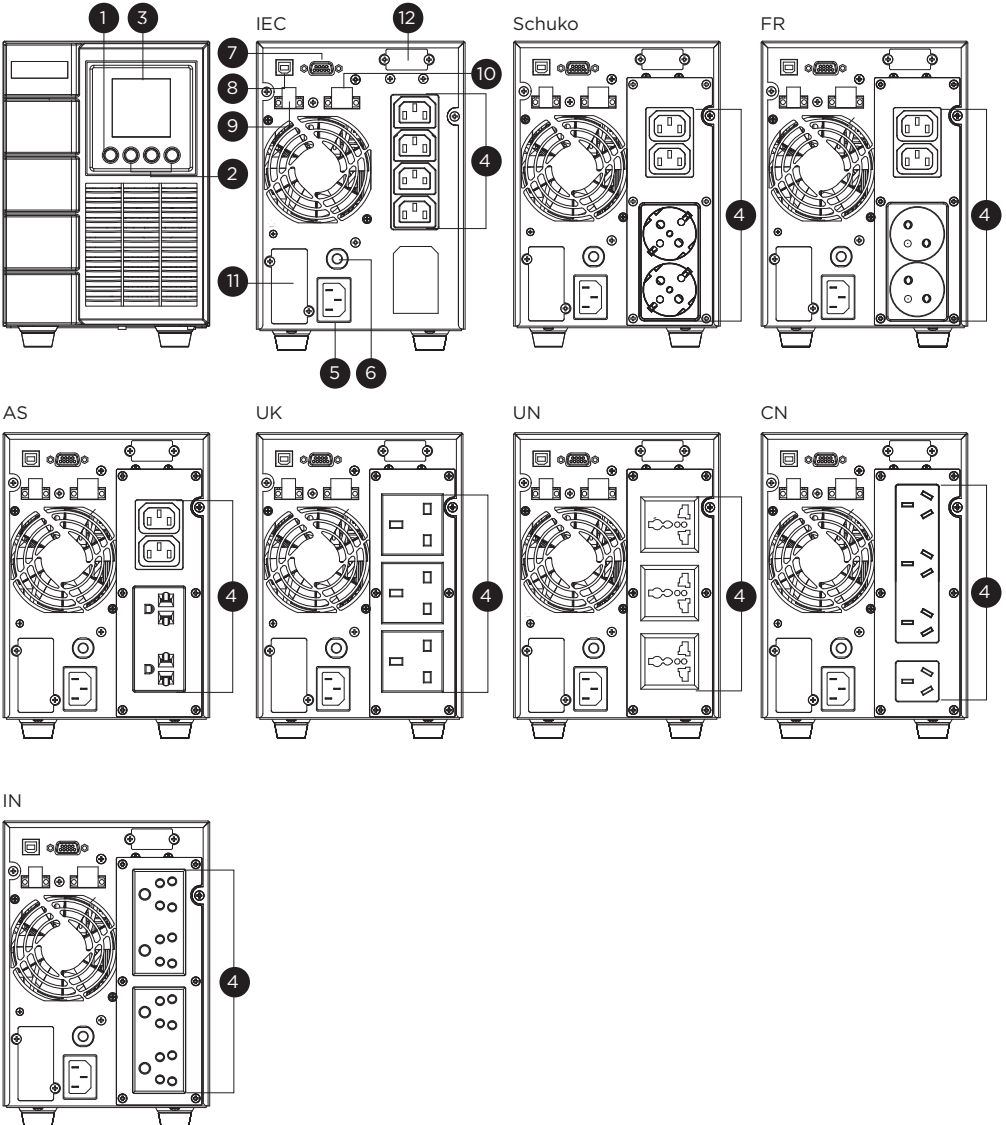

OVERVIEW

POWER MODULE FRONT/REAR PANEL DESCRIPTION

OLS3000EA

Front

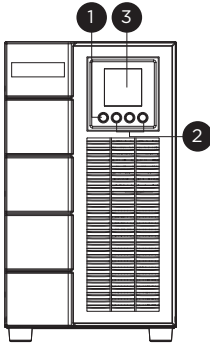

Rear

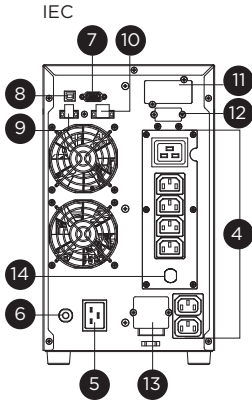

Schuko

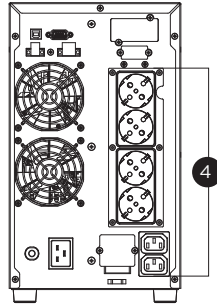

FR

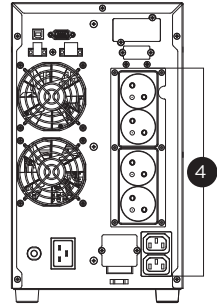

AS

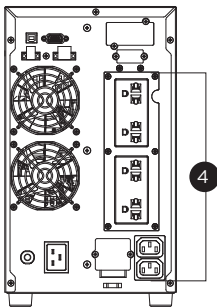

UK

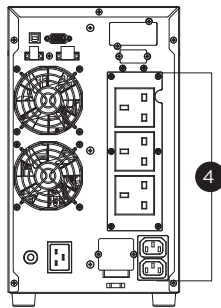

UN

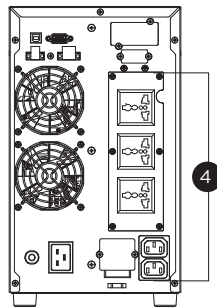

CN

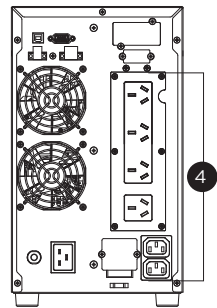

IN

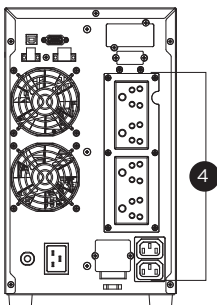

OVERVIEW

1. Power On/Off Button

Master ON/OFF switch for the UPS.

2. Function Buttons

Scroll DOWN, scroll UP, and ENTER.

3. UPS Status / Multifunction LCD Readout

Shows UPS status, information, settings and events.

4. Battery Backup & Surge Protected Outlets

Provide battery backup and surge protection. They ensure power is provided to connected equipment over a period of time during a power failure.

5. AC Input Inlet

Connect the AC Power cord to a properly wired and grounded outlet.

6. Input Circuit Breaker

Provide input current overload and fault protection.

7. Serial Port

Serial port provides RS-232 communication between the UPS and the computer. The UPS can control the computer's shutdown during a power outage through the connection while the computer can monitor the UPS and change its various programmable settings.

8. USB Port

This is a connectivity port which allows communication and control between the UPS and the connected computer. It is recommended to install the PowerPanel® Business Agent software on the PC/Server connected with the USB cord.

9. EPO (Emergency Power Off) Connector

Enables an emergency UPS power-off from a remote location.

10. Relay Output Connector

Convert UPS signals into real potential-free Dry Contacts for industrial control.

11. SNMP/HTTP Network Slot

Slot to install the optional SNMP card for remote network control and monitoring.

12. Extended Runtime Battery Module Connector

Connection for additional CyberPower Battery modules.

13. Output Terminal Block

Connect to your equipment.

14. Output Circuit Breaker

Provide output current overload and fault protection.

OVERVIEW

BATTERY MODULE FRONT/REAR PANEL DESCRIPTION

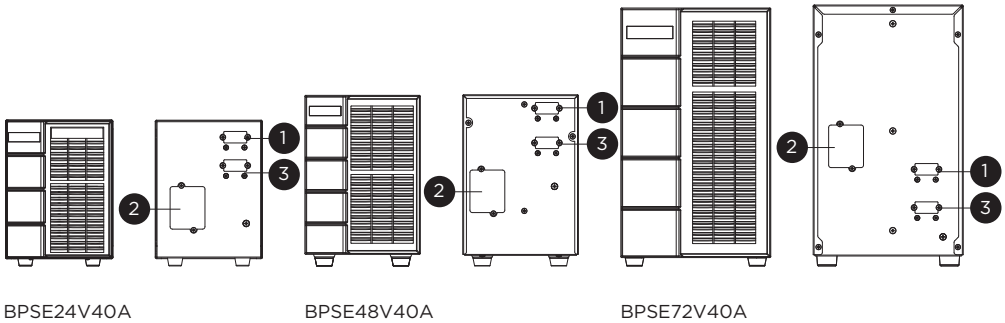

1. Input Connector

Use this input Connector to connect the Battery module to the Power module or to the next Battery module.

2. On-board Replaceable Fuse Cover

Replaceable fuse is accessible from the rear panel. It must be done by qualified personnel.

3. Output Connector

Use this output connector to daisy chain the next Battery module. Remove the connector cover for access.

CONNECTION 1: POWER MODULE WITH ONE BATTERY MODULE

Use the battery cable of the Battery module to connect the Battery module to the Power module.

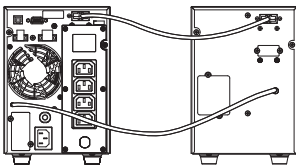

CONNECTION 2: POWER MODULE WITH MULTIPLE BATTERY MODULES

Step 1: Connect the first Battery module to the Power module via battery cable.

Step 2: Use the battery cable to connect the second Battery module to the first Battery module.

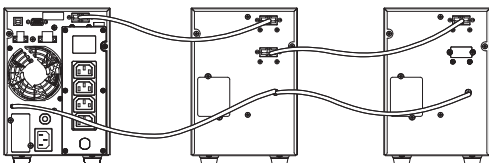

UPS SYSTEM STARTUP

After completing the hardware installation of the UPS, you are now ready to connect the UPS and connect your equipment.

To start the UPS:

1. Verify that the UPS input cable or terminal blocks are connected to AC source.
2. The UPS LCD shows “Standby Mode” and fans turn on.
3. Press and hold the ON/OFF button on the UPS front panel, you will hear a constant tone for 1 second, followed by a short beep. Release the button after the short beep.
4. UPS will perform a brief self-test lasting about 15 seconds. The LCD will be lighted up during this time.
5. The UPS is operating in Battery Mode first then transfer to Line Mode if Input power is qualification and powering the output.

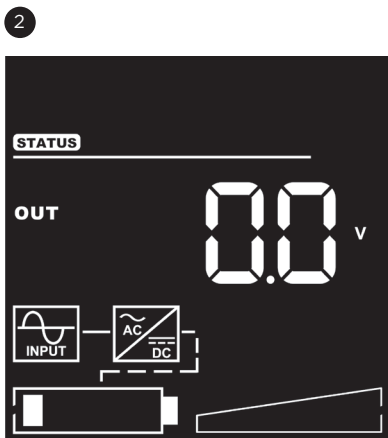

USING THE UPS SYSTEM

LCD PANEL



ITEM	BUTTON	FUNCTION DESCRIPTION
1	ON/OFF	Press this button for at least 3 seconds to turn on or turn off UPS.
2	DOWN	Press this button to scroll down in the LCD menu.
3	UP	Press this button to scroll up in the LCD menu.
4	ENTER	Press this button to select an option.

Silencing the alarm:

Press any button to silence the alarm. If the alarm status changes, the alarm will override the previous alarm silencing and will beep again.

LCD Display introduction:

There are 4 display Zones: ICON, CONTENT, EVENT CODE/INDEX and TOPOLOGY.

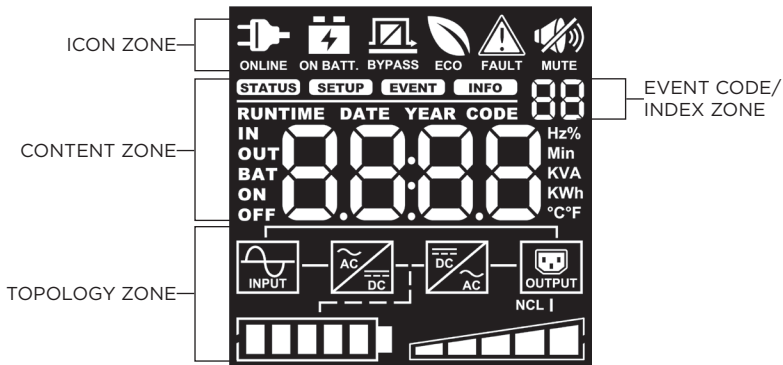

ICON ZONE:

In the top area, there are 6 ICONS for displaying the UPS working status, Fault (Warning) and Mute.

CONTENT ZONE:

The Content area is on the middle screen.

The top of Content area is for displaying UPS Menu.

The bottom area is the UPS status which depends on different UPS status to provide different information included Input / Output / Battery / Load parameters. Please refer to **APPENDIX** chapter for LCD Word Comparison Table.

EVENT CODE/INDEX ZONE:

In the upper right corner of the Content area, there are two seven-segment displays to show the event code when UPS fault. Besides, this area will show the index of setup, event and information menu.







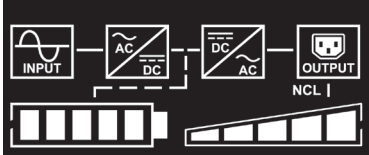

TOPOLOGY ZONE:

The Content area is on the bottom screen.

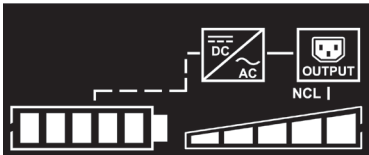
In this area, there are 6 TOPOLOGYS for displaying the UPS working status. The topology will be lighted up when the area is working.

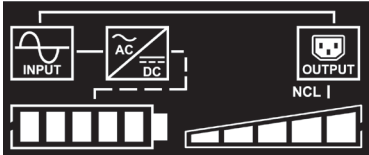
USING THE UPS SYSTEM

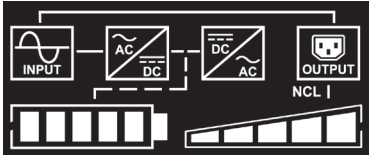
LCD SCREEN - ICON DESCRIPTION

UPS MODE	MODE DESCRIPTION	UPS TOPOLOGY: MODE DISPLAY
<p>Line Mode</p> 	<p>UPS is operating in Line Mode. The UPS is operating and protecting the equipment normally.</p>	
<p>Battery Mode</p> 	<p>UPS is operating in Battery Mode. A utility power failure has occurred. The UPS is using battery power to work and protect the equipment.</p>	
<p>Bypass Mode</p> 	<p>UPS is operating in Bypass Mode. A Warning or Fault has been detected and the UPS transfers output to utility power.</p>	
<p>ECO Mode</p> 	<p>UPS is operating in ECO (Economy) Mode. If Bypass quality is within the ECO mode setting specifications, the UPS will operate in Bypass until input power is disqualified per set specifications. At that time the UPS will automatically switch to Line Mode.</p>	
UPS STATUS	STATUS DESCRIPTION	
<p>Fault (Warning)</p> 	<p>A Warning or Fault has been detected and the UPS transfers output to utility power.</p>	
<p>Mute</p> 	<p>The audible alarm is disabled.</p>	

USING THE UPS SYSTEM

FUNCTION TREE

Menu





Status	Setup	Event Logs	Information
Output Voltage	Output Voltage	Log Item 1	EBM Number
Output Frequency	Sync Frequency Window	Log Item 2	UPS Rating
Input Voltage	Bypass V Window	Log Item 3	MCU Version
Input Frequency	Bypass Condition	Log Item 4	Model Name
Output Load	ECO Mode	Log Item 5	Date & Time
Output Ampere	Manual Bypass	Log Item 6	Next Battery Change
Output Watt	Audible Alarm	Log Item 7	IP Address
Output VA	EBM Number	Log Item 8	Subnet Mask
Load Energy	Generator Mode	Log Item 9	Gateway
Battery Voltage	Communication	Log Item 10	MAC
Battery Capacity	Converter Mode	Log Item 11	ESC
Battery Runtime	Screen Saver	Log Item 12	
	Clear Event Log	ESC	
	Signal Input		
	Period Battery Test		
	Reset Replace Battery		
	IP Address		
	Reset Load Energy		
	Battery Test		
	Alarm Test		
	Indicator Test		
	Fan Test		
	Date & Time		
	Automatic Restore		
	Mandatory Power Cycle		
	Recharged Delay Time		
	Recharged Capacity		
	Startup Delay		
	Low Battery Threshold		
	Low Runtime Threshold		
	Dry Relay Function (for 1.5/2/3KVA only)		
	ESC		

USING THE UPS SYSTEM

MAIN MENU: FUNCTION SELECT

1. Press the "ENTER" button in the Status function or select the "ESC" selection in the Setup/Event/Info function to enter the Main Menu.
2. The function block will blink when enter the Main Menu.
3. Press the "UP" and "DOWN" buttons to select the function.
4. Press the "ENTER" button to enter the selected function.

The Main Menu has 4 icons of different function listed in the table below.

FUNCTION SELECT MENU	ICON	DESCRIPTION
UPS STATUS		Displays the UPS status.
SET UP		Displays the UPS Set Up items that can be configured by the user.
EVENT LOGS		Displays the 12 most recent events, by event count, time (Year/Month/Day Hour: Minute), and event description.
INFORMATION		Displays the UPS information.

(1) STATUS

There are 12 types of UPS status Readout available for display.

1. Select "UPS Status" Icons
2. Press the "ENTER" button to enter the "UPS Status".
3. Press the "UP" and "DOWN" buttons to scroll through the "UPS Status" items shown in the table below.
4. Press the "ENTER" button to return to the Main Menu.

UPS STATUS ITEMS	DATA DISPLAYED	DESCRIPTION
OUTPUT VOLTAGE	= XXX.XV	Displays the Output Voltage
OUTPUT FREQUENCY	= [XX.XHz] / [CXX.XHz] / [nXX.XHz]	Displays the Output Frequency. [CXX.XHz] represents converter mode. [nXX.XHz] represents generator mode.
INPUT VOLTAGE	= XXX.XV	Displays the Input Voltage
INPUT FREQUENCY	= XX.XHz	Displays the Input Frequency
OUTPUT LOAD	= XXX%	Displays the Output Load as a Percentage of Maximum Load
OUTPUT CURRENT	= X.XA	Displays the Output Current
OUTPUT WATT	= XXXXW	Displays the Output Wattage

USING THE UPS SYSTEM

UPS STATUS ITEMS	DATA DISPLAYED	DESCRIPTION
OUTPUT VA	= XXXXVA	Displays the Output VA
LOAD ENERGY	= [XXXWh]/ [XXXXKWh]/ [XXXXKKWh]	Display UPS Load Energy Consumption. [XXXWh] represents the load energy < 1kWh. [XXXXKWh] represents the load energy >999Wh and < 1kWh.
BATTERY VOLTAGE	= XXX.XV	Displays the Battery Voltage
BATTERY CAPACITY	= XXX%	Displays the Estimated Percentage of Battery Capacity
BATTERY RUNTIME	= XXXM	Displays the Estimated Battery Runtime in Minutes

Example : Output Voltage 230.0V

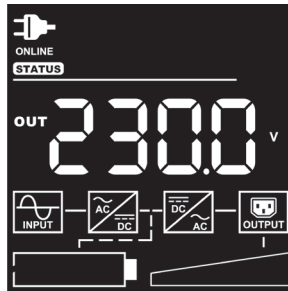

USING THE UPS SYSTEM

(2) SET UP

There are 31 UPS items that can be Set Up by the user.

1. Press the “UP” and “DOWN” buttons to select the “SETUP” ICON.
2. Press the “ENTER” button to enter the “SETUP” function.
3. Press the “UP” and “DOWN” buttons to scroll to the “SETUP” option.
4. When selecting the submenu item, the code number will be exhibited.
5. Press the “ENTER” button to select the “SETUP” submenu items shown in the table below.
6. Press the “UP” and “DOWN” buttons to scroll through the different parameters.
7. Press the “ENTER” button to select the parameter you want to set up.
8. You may be prompted “Save” to save the selection, if so press the “ENTER” button to save the setting. Some options are saved and started automatically. (See the following table and screen for additional details.)
9. Press the “ESC” to cancel or return to the previous SET UP menu.

INDEX	SET UP ITEMS	AVAILABLE SETTINGS	DEFAULT SETTING
01	Output Voltage	= [208V] [220V] [230V] [240V] Sets UPS output voltage	230V
02	Sync Freq Window	Range= [+/- 1%] [+/- 2%] [+/-3%] [+/- 4%] [+/- 5%] [+/- 6%] [+/- 7%] [+/- 8%] Sets output synchronization frequency range If input line frequency is outside this range, the UPS will lock in at the nominal frequency.	+/- 5%
03	Bypass V Window	Range= [+10%][+15%] / [-10%][-15%][-20%] Sets Bypass Voltage range	+10%/-15%
04	Bypass Condition	[Check Freq/Volt] [Check Volt Only] [No Bypass] Bypass Condition: The default setting [Check Freq/Volt] means the UPS will check the following specifications (1) and (2) when UPS has fault and needs transfer to Bypass. The setting [Check Volt Only] means the UPS will check the following specification (1) when UPS has fault and needs transfer to Bypass. (1) Bypass voltage is inside the range of "Bypass V Window". (2) Bypass frequency is inside the range of "Sync Freq Range". The setting [No Bypass] means the UPS is forbidden to transfer to Bypass when UPS has fault.	Check Freq/Volt

USING THE UPS SYSTEM

INDEX	SET UP ITEMS	AVAILABLE SETTINGS	DEFAULT SETTING
05	ECO Mode	[Disable] [Voltage= +/-15%] [Voltage = +/-10%] When ECO mode is enabled the UPS will check the following specifications of Bypass quality (1) Bypass voltage is inside the [V Range= +/-10%] (default setting) or [V Range= +/-15%]. (2) Bypass frequency is inside the +/-3Hz range of output nominal frequency.	Disable
06	Manual Bypass	[Disable] [Enable] When performing UPS maintenance, the user can manually transfer the connected load to Bypass without interrupting the output to the connected equipment.	Disable
07	Audible Alarms	[Disable] [Enable] [Only Bat Low] User can [Disable] or [Enable] the buzzer sound.	Enable
08	EBM Number	[0] [1] [2] [3] Sets the actual EBM (extended battery modules) number to get the correct estimated runtime.	0
09	Generator Mode	[Disable] [Enable] When the UPS input power source is a generator set the UPS will operate normally without transferring to Battery Mode when this is [Enable].	Disable
10	Communication	[Disable] [Enable] All communication ports on the UPS are [Disable] or [Enable]	Enable
11	Converter Mode	[Disable][Output Freq = 50Hz] [Output Freq = 60Hz] Sets [Output Freq = 50Hz] [Output Freq = 60Hz] to convert the input frequency to required output frequency.	Disable
12	Screen Saver	[Disable] [1 Minute] [5 Minutes] Sets the amount of time the LCD screen stays on after no user input. The [Disable] option keeps the LCD screen on at all times.	5 Minutes
13	Clear Event Log	[Activate?] Clears all the events stored in the LCD Control Panel Event Log.	None
14	Signal Inputs	[Disable] [EPO] [ROO] Sets [EPO] (Emergency Power Off) to shutdown the UPS remotely when the contact is open. Sets [ROO] (Remote On/Off) to turn On the UPS remotely when the contact is close and turn Off the UPS remotely when the contact is open. The On/Off power button on front panel will be disabled when set to [ROO].	Disable

USING THE UPS SYSTEM

INDEX	SET UP ITEMS	AVAILABLE SETTINGS	DEFAULT SETTING
15	Period Battery Test	[Disable] [1 Week] [2 Weeks] [3 Weeks] [4 Weeks] Sets the battery test period.	Disable
16	Reset Replace Battery	[Clear] [Setup] Manually reset the Battery Replacement date.	None
17	IP Address	[DHCP] [Manual] Select [Mode:Manual] to set IP Address, Subnet Mask and Gateway to network interface (RMCARD) or select DHCP to set automatically.	DHCP
18	Reset Load Energy	[Activate] Reset Load Energy Consumption (KWH) value.	None
19	Battery Test	[Activate] Starts a manual battery test, UPS will operate 10 seconds on Battery mode to check battery condition.	None
20	Alarm Test	[Activate] Starts a manual Alarm test, buzzer will sound for 5 seconds.	None
21	Indicator Test	[Activate] Starts a manual Indicator test.	None
22	Fan Test	[Activate] Starts a manual Fan test, UPS will operate fan with full speed 5 seconds.	None
23	Date & Time	[----] [--:--] [--:--] set Year/Month/Day Hour: Minute: Second to UPS or get Date & Time from PPBE (Agent) or RMCARD automatically.	None
24	Automatic Restore	[Disable] [Enable] User can [Disable] or [Enable] the auto restart function.	Enable
25	Mandatory Power Cycle	[Disable] [Enable] User can [Disable] or [Enable] the Mandatory power cycle function.	Disable
26	Recharged Delay Time*	[0 Minute] [1 Minute] [2 Minutes] [3 Minutes] [5 Minutes] [10 Minutes] [20 Minutes] [30 Minutes] [60 Minutes] When the utility power restores, the UPS will start to recharge until the specified delay is expired before restoring output power.	0 Minute
27	Recharged Capacity*	[0%] [15%] [30%] [45%] [60%] [75%] [90%] When the utility power restores, the UPS will start to recharge until the specified battery capacity is met before restoring output power.	0%

USING THE UPS SYSTEM

INDEX	SET UP ITEMS	AVAILABLE SETTINGS	DEFAULT SETTING
28	Startup Delay	[0 Minute] [1 Minute] [2 Minutes] [3 Minutes] [4 Minutes] [5 Minutes] [6 Minutes] [7 Minutes] [8 Minutes] [9 Minutes] [10 Minutes] When the utility power restores, the UPS will delay the restoration of output power.	0 Minute
29	Low Battery Threshold**	[20%][25%] [30%][35%][40%][45%][50%][55%] [60%][65%] Sets the capacity to alarm battery low.	20%
30	Low Runtime Threshold**	[0 Minute][1 Minute][2 Minutes][3 Minutes]..... [29 Minutes][30 Minutes] Sets the Runtime to alarm battery low.	5 Minutes
31	Dry Relay Function***	[I/P Power Fail] [Battery Low] [Summary Alarm] [UPS On Bypass] [UPS Fail] Sets the Dry Relay Function output.	UPS Fail

* UPS will restore output when reaches the setting of “26. Recharged Delay Time” **and** “27. Recharged Capacity” at the same time.

** The battery low alarm triggers when “29. Low Battery Threshold” **or** “30. Low Runtime Threshold” is reached.

*** Dry Relay Function is only available for OLS1500/2000/3000EA.

Example: Index 01, SETUP: Output Voltage to 220V then press enter to save the setting.



USING THE UPS SYSTEM

(3) EVENT LOGS

The UPS will record the 12 most recent system events in the Event Log.

1. Select “EVENT” Icons.
2. Press the “ENTER” button to enter the “Event Logs”.
3. Press the “UP” and “DOWN” buttons to scroll through the “Event Logs”. The UPS will record events listed in the table below.

INDEX	EVENT DISPLAYED	DESCRIPTION
XX	Event Content	Event description [Please check the Event Code List.]

4. When selecting the submenu item, the index which represents the sequence will be exhibited.
5. Press the “ENTER” button to see the event code and event date/time.

INDEX	EVENT DISPLAYED	DESCRIPTION
XX	[C-XX] (XXD)(XXH)(XXM) / [- - - -] [---:--] [---:--]	Event Code Number : [C-XX] Event date and time : (XXD)(XXH)(XXM) (without PowerPanel® Business or RMCARD) [- - - -] [---:--] [---:--] [Year][Month. Day][Hour: Minute] (with PowerPanel® Business or RMCARD)

6. Press the “ESC” to return to the Main Menu.

Example: Event 1: Battery Failure / 21min ago

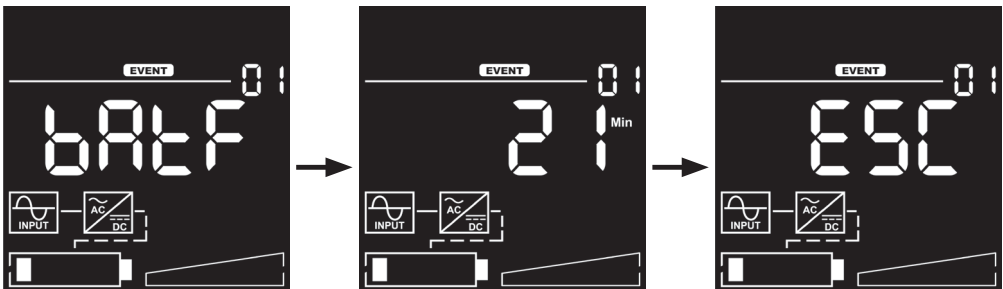

USING THE UPS SYSTEM

(4) INFORMATION

There are 10 UPS Information items that can be tested by the user.

1. Select “INFO” Icons.
2. Press the “ENTER” button to enter the “INFO”.
3. Press the “UP” and “DOWN” buttons to scroll through the “INFO” items shown in the table below.
4. Press the “ESC” to return to the Main Menu.

INDEX	INFORMATION ITEMS	DATA DISPLAYED	DESCRIPTION
01	EBM Number	X	Displays the EBM (extended battery modules) number.
02	UPS Rating	XXXXVA/XXXXW	Displays the UPS Rating
03	MCU Version	[XXXX]	Displays the UPS MCU Firmware Version
04	Model Name	[OLSX] [000E] [RT2U] [A]	Displays the UPS Model Name
05	Date and Time	[- - - -] [- . - -] [- - : - -]	Displays the present Date & Time
06	Next BATT Change	[- - - -] [- . - -]	Displays the next Battery Change Date.
07	IP	[1.XXX] [2.XXX] [3.XXX] [4.XXX]	Display the network IP address
08	Subnet Mask	[1.XXX] [2.XXX] [3.XXX] [4.XXX]	Display the network Subnet Mask
09	Gateway	[1.XXX] [2.XXX] [3.XXX] [4.XXX]	Display the network Gateway
10	MAC	[XX.XX] [XX.XX] [XX.XX]	Display the network card MAC address

Example: Index 1, EBM Number=0

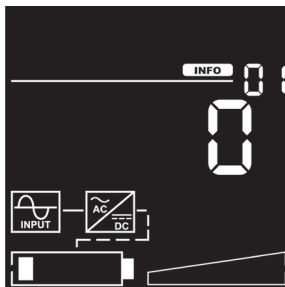

USING THE UPS SYSTEM

EVENT CODE LIST

EVENT CODE	EVENT CONTENT	LCD DISPLAY	DESCRIPTION
01	Over Charge	08CH	The Battery has been charged too High voltage.
02	Charger Failure	CHGF	The Battery Charger has malfunctioned.
04	Battery Low	BATL	The Battery has been discharged to low level.
05	Battery Failure	BATF	The UPS has detected battery failure.
06	BAT Disconnected	BATd	The UPS has not detected batteries.
07	Service Battery	SbAT	The Battery Replacement Date has reached the maintenance period.
12	Load Over Set%	LLAL	The UPS has detected Output Watt or VA has exceeded user set parameter.
21	Output short	OPSt	The UPS has detected output short.
22	Output Overload	OPOL	The UPS has detected Output Watt or VA are too High.
25	EPO OFF	E0FF	The UPS has been turned off by EPO.
27	ROO OFF	R0FF	The UPS has been turned off by ROO.
30	Inverter Fault	InvF	The inverter has malfunctioned.
31	High Output Voltage	H IOP	The UPS has detected Inverter voltage too High.
32	Low Output Voltage	LOOP	The UPS has detected Inverter voltage too Low.
33	Over Temperature	08tP	The UPS has detected internal temperature too High.
34	Fan Error	FAnE	The UPS has detected a fan malfunction.
35	Rear Fan Error		The UPS has detected a rear fan malfunction.
36	Middle Fan Error		The UPS has detected a middle fan malfunction.
37	Front Fan Error		The UPS has detected a front fan malfunction.

USING THE UPS SYSTEM

EVENT CODE LIST

EVENT CODE	EVENT CONTENT	LCD DISPLAY	DESCRIPTION
40	Bus Fault	BUSF	The UPS has detected DC Bus too High or Low.
41	Bus Fault +High		The UPS has detected +DC Bus too High.
42	Bus Fault +Low		The UPS has detected +DC Bus too Low.
43	Bus Fault -High		The UPS has detected -DC Bus too High.
44	Bus Fault -Low		The UPS has detected -DC Bus too Low.
50	Input Power Fail	IPPF	The UPS has detected input voltage or frequency out of range.
51	Input V+Hz out of range		The UPS has detected input voltage and frequency out of range.
52	Input V out of range		The UPS has detected input voltage out of range.
53	Input Hz out of range		The UPS has detected input frequency out of range.
54	Line Abnormal	L IAb	The UPS has detected the utility is out of range when the UPS is running auto-restart process.
N/A	Ready ON	FdOn	The UPS has been turned on.
N/A	Shutdown	SHUT	The UPS has been shutdown.
N/A	Sleep Mode	SLPn	The UPS has been entered sleep mode.
N/A	Battery Test	bAtt	The Batteries have been tested.

USING THE UPS SYSTEM

LCD WORD INDEX

WORD	LCD DISPLAY	DESCRIPTION
NO	NO	NO Bypass/NO IP Address
ENA	ENA	Enable
DIS	DIS	Disable
ACT	ACT	Activate
SAVE	SAVE	Save
ESC	ESC	Escape
VOFE	VOFE	Bypass condition: Check Voltage and Frequency
OLVO	OLVO	Bypass condition: Check only Voltage
OLBL	OLBL	Buzzer enable only battery Low
IPPF	IPPF	Dry relay function output: Input power fail
BATL	BATL	Dry relay function output: Bat Low
SUML	SUML	Dry relay function output: Summary alarm
BYPA	BYPA	Dry relay function output: Bypass
UPSF	UPSF	Dry relay function output: UPS fail
CLER	CLER	Clear
SETU	SETU	Setup
EPO	EPO	Emergency power off
ROO	ROO	Remote On/Off
DHCP	DHCP	IP address: DHCP



USING THE UPS SYSTEM

LCD WORD INDEX



WORD	LCD DISPLAY	DESCRIPTION
MANU	MANU	IP address: Manual
BATE	BATE	Battery test
ALTE	ALTE	Alarm test
INTE	INTE	Indicator test
FATE	FATE	Fan test
NULL	NULL	NULL

TROUBLESHOOTING

LCD will use FAULT ICON with RED to indicate the Fault or Warning status.

EVENT CODE	WARNING	ICON	POSSIBLE CAUSE	SOLUTION
N/A	Battery Mode	 (Yellow)	UPS is operating on battery power.	Save your data and perform a controlled- shutdown.
01	Over Charge	 (Red)	Battery is overcharged.	Remove battery connector and check charger voltage.
04	Battery Low		UPS is operating on battery power and the alarm triggers when the set percentage of battery capacity or remaining back-up time is reached. UPS will be shutting down soon due to extremely low battery voltage.	UPS will restart automatically when acceptable utility power returns.
05	Battery Failure		UPS has failed in Battery Test.	Check battery connector and battery fuse. Contact technical support to replace the battery.
06	BAT Disconnected		Missing battery power.	Check battery connector and battery fuse.
07	Service Battery		The Battery Replacement Date has reached the recommended 3 year maintenance period.	If batteries have been recently replaced, then reset the Battery Replacement Date using PowerPanel® Business Edition-Agent software, RMCARD interface or through the LCD control panel on the UPS (See LCD Setting Configuration).
12	Load Over XXX%		Your equipment requires more power than the setting in the Power Management Software (Power Panel® Business) will allow.	Shut off the non-essential equipment or increase the level in the Power Management Software.

TROUBLESHOOTING

EVENT CODE	WARNING	ICON	POSSIBLE CAUSE	SOLUTION
21	Output Short	 (Red)	Output short circuit.	Your attached equipment may have problems, please remove them and check again.
22	Output Overload		Your equipment requires more power than the UPS can provide. If the UPS is in Line Mode then it will transfer to Bypass Mode; if the UPS is in Battery Mode it will shutdown.	Shut off non-essential equipment. If this solves the overload problem, the UPS will transfer to normal operation.
25	EPO OFF		Missing the EPO connection.	Check the EPO connection.
27	ROO OFF		Missing the ROO connection.	Check the ROO connection.
33	Over Temperature		High temperature sensor activates protection.	Check the fan for operation and if the ventilation hole has been covered.
54	Line Abnormal		Utility power is out of range for the UPS to auto-restart.	Check whether voltage or frequency of utility power is out of range.
EVENT CODE	FAULT		ICON	POSSIBLE CAUSE
02	Charger Failure	 (Red)	Charger has failed.	Contact CyberPower for assistance.
31	High Output V		Output voltage is too high.	Shut down UPS and turn off input breaker. Contact CyberPower for assistance.
32	Low Output V		Output voltage is too low.	
40	Bus Fault		Internal DC bus voltage is too high or too low.	
34	Fan Error		Internal Fan has failed.	Perform a Fan Test and check the Alarm. If the Alarm continues, Shut down UPS and turn off input breaker. Contact CyberPower for assistance.

MAINTENANCE

Storage

To store your UPS for an extended period, cover it and store with the battery fully charged. Recharge the battery every three months to ensure battery life.



Warning: High voltage - Risk of Electric Shock

CAUTION! Only use replacement batteries that are certified by Cyber Power Systems. Use of incorrect battery type is an electrical hazard that could lead to explosion, fire, electric shock, or short circuit.

CAUTION! Batteries contain an electrical charge that can cause severe burns. Before servicing batteries, please remove any conductive materials such as jewelry, chains, wrist watches, and rings.

CAUTION! Do not open or mutilate the batteries. Electrolyte fluid is harmful to the skin/eyes and may be toxic.

CAUTION! To avoid electric shock, turn off and unplug the UPS from the wall receptacle before servicing the battery.

CAUTION! Only use tools with insulated handles. Do not lay tools or metal parts on top of the UPS or battery terminals.

Replacement Batteries

Please refer to the front side of the UPS for the model number of the correct replacement batteries. For battery procurement, log onto www.cyberpower.com, or contact your local dealer.

When the Replace Battery the LCD displays Service Battery, use PowerPanel® Business Edition Agent software or log on to the RMCARD to perform a runtime calibration to verify battery capacity is sufficient and acceptable.

CAUTION! Batteries replacement must be performed by qualified personnel.

Battery Disposal



Do Not Discard

Batteries are considered hazardous waste and must be disposed of properly. Contact your local government for more information about proper disposal and recycling of batteries. Do not dispose of batteries in fire.

TECHNICAL SPECIFICATIONS



































Models	OLS1000EA	OLS1500EA	OLS2000EA	OLS3000EA
Configuration				
Capacity (VA)	1000	1500	2000	3000
Capacity (Watts)	900	1350	1800	2700
Form Factor	Tower			
Energy-saving Technology	Yes, ECO Mode Efficiency \geq 95%			
Input				
Input Voltage Range	80- 300 Vac			
Input Frequency Range	40-70Hz			
Input Power Factor	\geq 0.99			
Cold Start	Yes			
Output				
Output Waveform	Pure Sine Wave			
Output Voltage	208, 220, 230, 240Vac \pm 1%			
Output Frequency	50 / 60Hz (Auto-Sensing or Configurable) \pm 0. 5Hz *			
Transfer Time (Typically)	0ms			
Rated Power Factor	0.9			
Harmonic Distortion	THD < 3% at Linear Load, < 5% at Non-linear Load			
Crest Factor	3 : 1			
ECO Mode Voltage Regulation	\pm 10%, \pm 15% (Configurable)			
Protection				
Surge Protection	Surge Suppression \geq 345(Joules)			
Overload Protection	Line Mode: 105-110% Overload warning only 110-120% Warning, transfer to bypass after 60s >120% Transfer to bypass immediately Battery Mode: 105-110% Overload warning only 110-120% Warning, shutdown after 10s >120% Shutdown immediately			
Short Circuit Protection	UPS Output Cut off Immediately / Circuit Breaker Protection			

TECHNICAL SPECIFICATIONS

Models	OLS1000EA	OLS1500EA	OLS2000EA	OLS3000EA
Battery				
Specifications	(2) 12V	(4) 12V	(4) 12V	(6) 12V
Recharge Time (Typically)	4 Hours			
Sealed, Maintenance Free	Yes			
Status Indicators				
LCD Screen	Graphic LCD			
Audible Alarms	Battery Mode, Battery Test Fail, Battery Low, Overload, UPS Fault, Over Charged, Fan Failure			
Environment				
Operating Temperature	32°F to 104°F (0°C to 40°C)			
Operating Relative Humidity	20 to 90% Non-Condensing			
Management & Communications				
On-Device Features	Self Test, Auto-Charge, Auto-Restart, Auto-Overload Recovery			
Connectivity Ports	(1) Serial Port (RS232), (1) USB Port			
SNMP/HTTP Capable	(1) Expansion Port (With optional RMCARD 205)			
Software				
Power Management Software	PowerPanel® Business			
Physical				
Dimension (WxHxD)mm	140 x 191 x 327	151 x 225 x 394		196 x 337 x 416
Net Weight (kg)	14.5	14.8	17.4	21.3

* Within 50/60HZ $\pm 5\%$ by default, the output frequency is synchronization with input mains. User can adjust the acceptable range for output frequency ($\pm 1, 2, 3, 4, 5, 6, 7, 8\%$). When UPS work on Converter Mode, the output frequency is regulated at 50/60Hz $\pm 0.5\%$ with load derating by 40%.

APPENDIX - LCD WORD COMPARISON TABLE

WORD	LCD DISPLAY	WORD	LCD DISPLAY	WORD	LCD DISPLAY	WORD	LCD DISPLAY
0		A		L		V	
1		B		M		W	
2		C		N		X	
3		D		O		Y	
4		E		P			
5		F		Q			
6		G		R			
7		H		S			
8		I		T			
9		J		U			

Cyber Power Systems, Inc.

www.cyberpower.com

11F., No.26, Jinzhuang Rd., Neihu Dist., Taipei City 114, Taiwan

Entire contents copyright © 2020 Cyber Power Systems, Inc., All rights reserved. Reproduction in whole or in part without permission is prohibited. PowerPanel® Business and PowerPanel® Personal are trademarks of Cyber Power Systems, Inc.

