

# 4x4 MiMo 4G/5G Dome Combination Antenna Range

PANORAMA ANTENNAS

L[G]M[X]M4[X]-6-60[-24-58]



Low Profile 4x4 4G/5G MiMo

Up to 6 x 6 MiMo Dual Band WiFi

Optional GPS/GNSS Active Antenna 26dB LNA

The L[G]M[X]M4[X]-6-60[-24-58] range has been designed to provide 4x4 4G/5G MiMo performance from 617-960/1710-6000MHz in a robust low profile package. The flexible platform allows the main elements to be combined with a number of other functions including GPS/GNSS and up to 6x6 MiMo WiFi 2.4/5.0GHz.

The antenna is designed to be panel mounted and can be fitted on a conductive or non-conductive panel. Supplied with integrated flame retardant RG174 cables (Compliant to UNECE 118.01 and EN45545-2) and a halogen free flame retardant radome the antenna is suitable for many environments and applications.

The LGM variants have an integrated GPS/GNSS module supporting GPS, Glonass, Galileo, QZSS and Compass with 26dB LNA gain. This GPS module features advanced filtering for LTE B13/14 designed to minimise potential in band interference.

The antenna is available with a black or white radome which meets IK10 for vandal resistance and IP69K for Ingress protection.

## Technical Drawing

LGMHM4-6-60-24-58 Shown

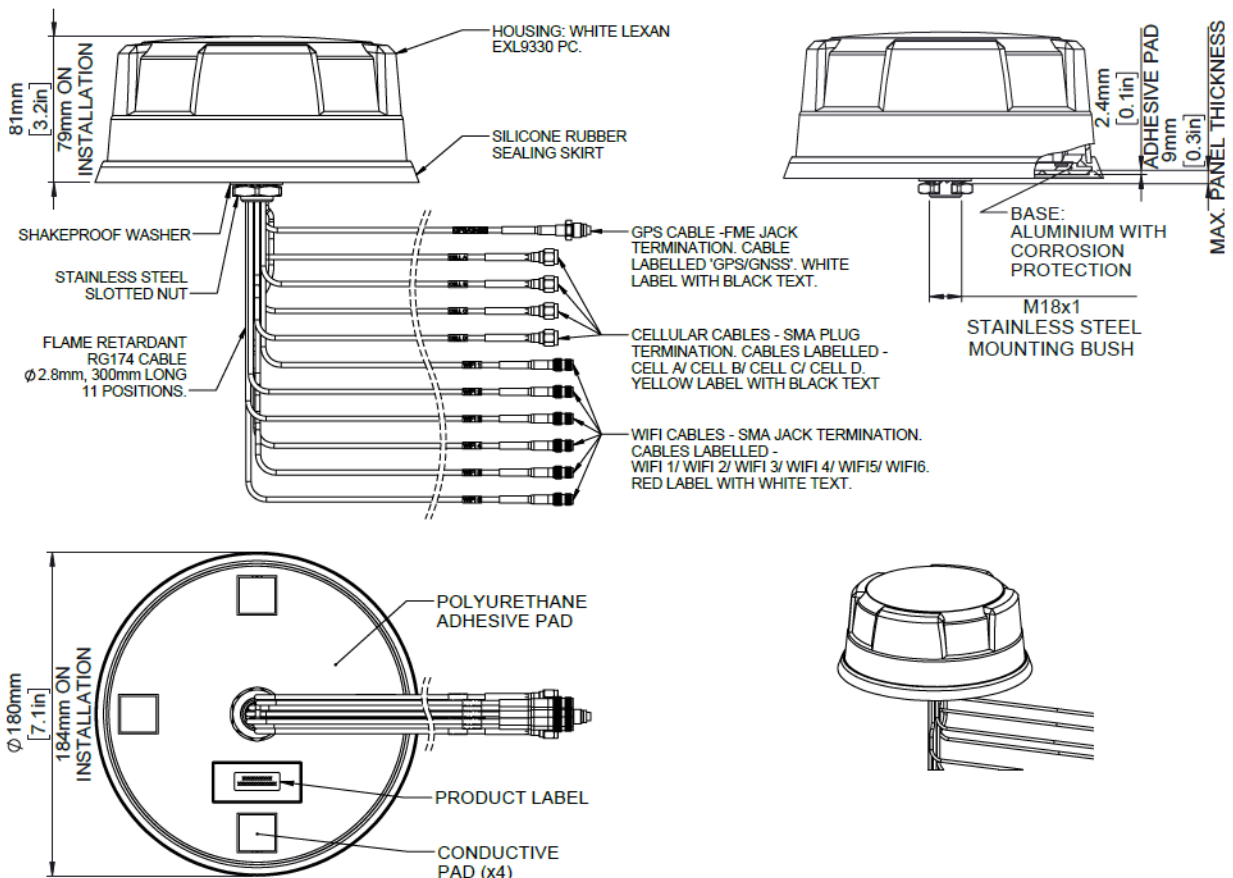

# 4x4 MiMo 4G/5G Dome Combination Antenna Range

PANORAMA ANTENNAS

L[G]M[X]M4[X]-6-60[-24-58]

Part No.		LGMHM4-6-60-24-58	LGMHM4B-6-60-24-58	LGMQM4-6-60-24-58	LGMQM4B-6-60-24-58
<b>Electrical Data</b>					
Frequency Range (MHz)	4G/5G Elements	4x 617-960 / 1710-6000			
	WiFi Elements	6x 2.4/4.9-6GHz		4x 2.4/4.9-6GHz	
Peak Gain: Isotropic : (dBi)	4G/5G Elements	617-960MHz	4		
		1710-3800MHz	8		
		4900-6000MHz	9		
	WiFi Elements	2.4 GHz	9		
		4.9-6.0GHz	9		
Typical Efficiency **	4G/5G Elements	617-960MHz	>50%		
		1710-3800MHz	>75%		
		4900-6000MHz	>85%		
	WiFi Elements		>70%		
Isolation ***	4G/5G Elements		>10dB		
	Wifi Elements		>12dB		
Correlation Co-efficient	4G/5G Elements		< 0.2		
	WiFi Elements		<0.1		
Nominal Impedance			50Ω		
<b>GPS/GNSS Data</b>					
Frequency Range (MHz)			1562-1612		
VSWR			<2.0:1 ± 4MHz		-
Gain: LNA			26dB		
Out of band rejection			>40dB (@ > +/- 100MHz f)		
Typical Noise Figure			≤ 2.7dB		
Notch Filter rejection @787MHz			24dB		
Operating Voltage			3 - 5V DC		
Typical Current (mA)			15		
<b>Mechanical Data</b>					
Dimensions (mm)	Height		80 (3.1")		
	Diameter		180 (7.1")		
Operating Temp			-40° / +80°C (-40° / +176°F)		
Colour	White	Black	White	Black	
Ingress Protection			IP69K		
<b>Mounting Data</b>					
Mounting type			Panel mount		
Max panel thickness (mm)			7 (0.27")		
Mounting hole (mm)			19 (3/4")		
<b>Cable Data</b>					
All Cables	Type		RG174 -FR (UN ECE118.01 Compliant)		
	Diameter (mm)		2.8 (0.1")		
	Length (m)		0.3 (1')		
<b>Terminations</b>					
4G/5G			SMA (m)		
WiFi			SMA (f)		
GPS/GNSS			FME (f)		

# 4x4 MiMo 4G/5G Dome Combination Antenna Range

PANORAMA ANTENNAS

L[G]M[X]M4[X]-6-60-[24-58]

Part No.		LGMTM4-6-60-24-58	LGMTM4B-6-60-24-58	LGMDM4-6-60-24-58	LGMDM4B-6-60-24-58	
<b>Electrical Data</b>						
Frequency Range (MHz)	4G/5G Elements	4x 617-960 / 1710-6000				
	WiFi Elements	3x 2.4/4.9-6GHz		2x 2.4/4.9-6GHz		
Peak Gain: Isotropic : (dBi)†	4G/5G Elements	617-960MHz			4	
		1710-3800MHz			8	
		4900-6000MHz			9	
	WiFi Elements	2.4 GHz			9	
		4.9-6.0GHz			9	
Typical Efficiency **	4G/5G Elements	617-960MHz			>50%	
		1710-3800MHz			>75%	
		4900-6000MHz			>85%	
	WiFi Elements			>70%		
Isolation ***	4G/5G Elements			>10dB		
	WiFi Elements			>12dB		
Correlation Co-efficient	4G/5G Elements			< 0.2		
	WiFi Elements			<0.1		
Nominal Impedance					50Ω	
<b>GPS/GNSS Data</b>						
Frequency Range (MHz)					1562-1612	
VSWR					<2.0:1 ± 4MHz	
Gain: LNA					26dB	
Out of band rejection					>40dB (@ > +/- 100MHz f)	
Typical Noise Figure					≤ 2.7dB	
Notch Filter rejection @787MHz					24dB	
Operating Voltage					3 - 5V DC	
Typical Current (mA)					15	
<b>Mechanical Data</b>						
Dimensions (mm)	Height					80 (3.1")
	Diameter					180 (7.1")
Operating Temp					-40° / +80°C (-40° / +176°F)	
Colour	White	Black	White	Black		
Ingress Protection					IP69K	
<b>Mounting Data</b>						
Mounting type					Panel mount	
Max panel thickness (mm)					7 (0.27")	
Mounting hole (mm)					19 (3/4")	
<b>Cable Data</b>						
All Cables	Type	RG174 -FR (UN ECE118.01 Compliant)				
	Diameter (mm)	2.8 (0.1")				
	Length (m)	0.3 (1')				
<b>Terminations</b>						
4G/5G					SMA (m)	
WiFi					SMA (f)	
GPS/GNSS					FME (f)	

# 4x4 MiMo 4G/5G Dome Combination Antenna Range

PANORAMA ANTENNAS

L[G]M[X]M4[X]-6-60[-24-58]

Part No.		LGMM4-6-60	LGMM4B-6-60	LPMM4-6-60	LPMM4B-6-60
<b>Electrical Data</b>					
Frequency Range (MHz)	4G/5G Elements	4x 617-960 / 1710-6000			
Peak Gain: Isotropic : (dBi)†	4G/5G Elements	617-960MHz	4		
		1710-3800MHz	8		
		4900-6000MHz	9		
Typical Efficiency **	4G/5G Elements	617-960MHz	>50%		
		1710-3800MHz	>75%		
		4900-6000MHz	>85%		
Isolation ***	4G/5G Elements	>10dB			
Correlation Co-efficient	4G/5G Elements	< 0.2			
Nominal Impedance		50Ω			
<b>GPS/GNSS Data</b>					
Frequency Range (MHz)		1562-1612	-		
VSWR		<2.0:1 ± 4MHz	-		
Gain: LNA		26dB	-		
Out of band rejection		>40dB (@ > +/- 100MHz f)	-		
Typical Noise Figure		≤ 2.7dB	-		
Notch Filter rejection @787MHz		24dB	-		
Operating Voltage		3 - 5V DC	-		
Typical Current (mA)		15	-		
<b>Mechanical Data</b>					
Dimensions (mm)	Height	80 (3.1")			
	Diameter	180 (7.1")			
Operating Temp		-40° / +80°C (-40° / +176°F)			
Colour		White	Black	White	Black
Ingress Protection		IP69K			
<b>Mounting Data</b>					
Mounting type		Panel mount			
Max panel thickness (mm)		7 (0.27")			
Mounting hole (mm)		19 (3/4")			
<b>Cable Data</b>					
All Cables	Type	RG174 -FR (UN ECE118.01 Compliant)			
	Diameter (mm)	2.8 (0.1")			
	Length (m)	0.3 (1')			
<b>Terminations</b>					
4G/5G		SMA (m)			
GPS/GNSS		FME (f)	-		

\*\*Typical efficiency shown for single element of relevant type simulated in CST Microwave Studio on 600x600mm (23.6"x23.6") ground plane excluding cable loss.

\*\*\* Isolation shown is worst case across all element pairings measured on 600x600mm (23.6"x23.6") ground plane with 0.5m (1'5") of Cable.

† Typical peak gain shown for single element of relevant type simulated in CST Microwave Studio on 600x600mm (23.6"x23.6") ground plane excluding cable loss.

# 4x4 MiMo 4G/5G Dome Combination Antenna Range

L[G]M[X]M4[X]-6-60[24-58]

## Electrical Data

Typical VSWR - 4G/5G Elements\*

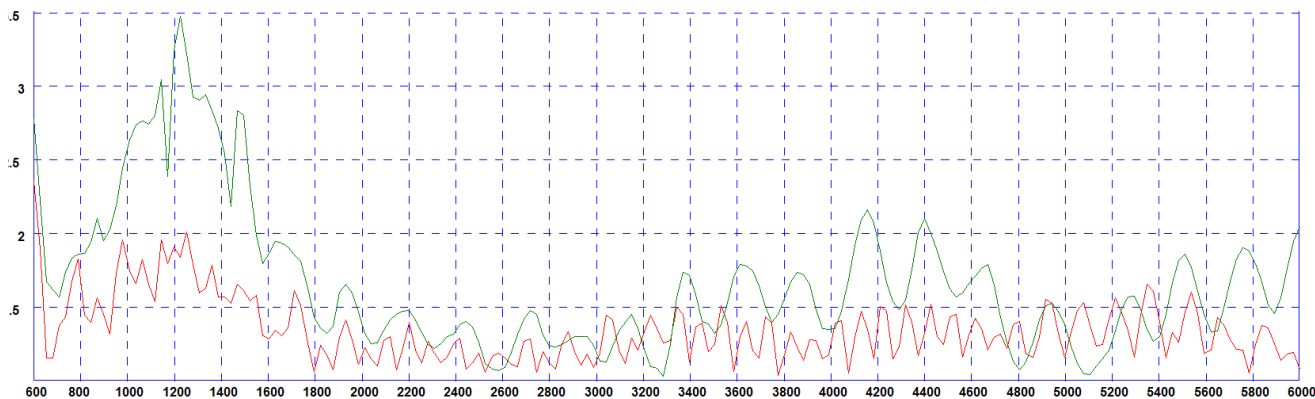

\* Green Trace measured with 0.5m (1.5') of RG174 cable Red Trace measured with 5m (17') of CS32 Cable both on a 600x600mm (2'x2') groundplane

Typical Isolation - 4G/5G Elements\*

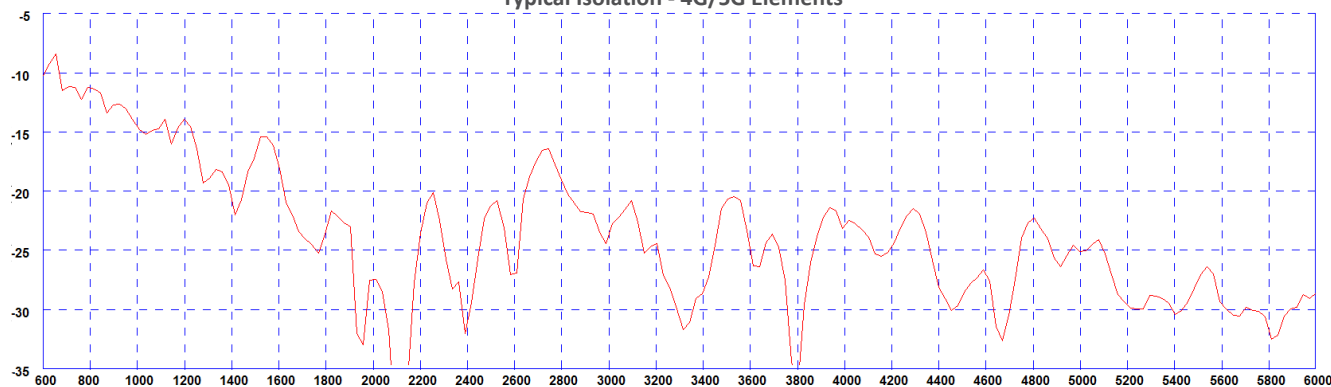

\* measured with 0.5m (1.5') of RG174 cable on a 600x600mm (2'x2') groundplane

Typical VSWR - WiFi Elements\*

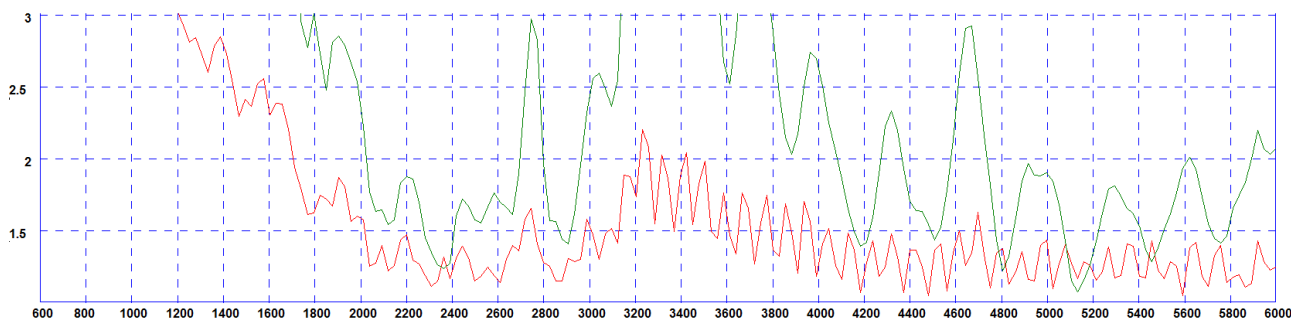

\* Green Trace measured with 0.5m (1.5') of RG174 cable Red Trace measured with 5m (17') of CS32 Cable both on a 600x600mm (2'x2') groundplane

# 4x4 MiMo 4G/5G Dome Combination Antenna Range

PANORAMA ANTENNAS

L[G]M[X]M4[X]-6-60[-24-58]

Typical Efficiency- 4G/5G Elements\*

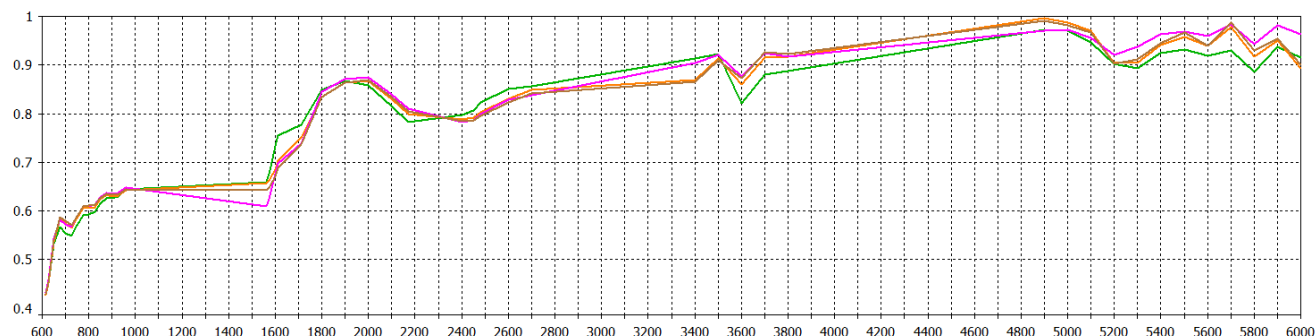

\* Efficiency modelled with CST Microwave Studio with antenna mounted on 600x600mm (2'x2') ground plane and ignores cable losses

Typical Peak Gain - 4G/5G Elements\*

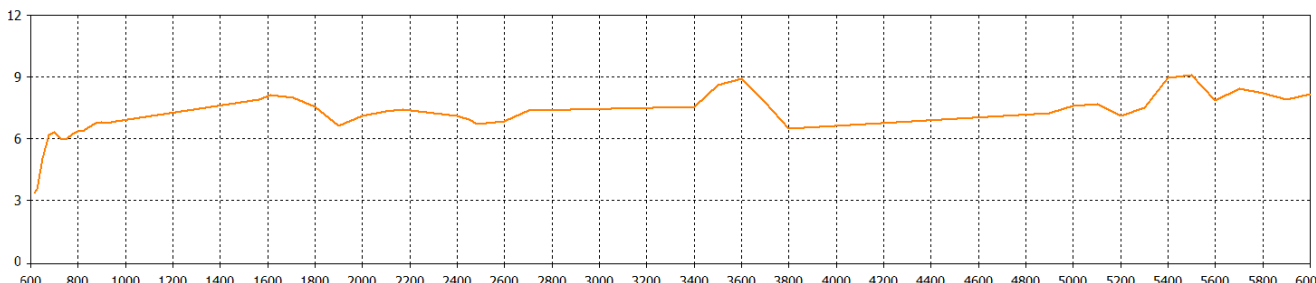

\*Swept peak gain modelled with one element fed in CST Microwave Studio on a 600x600mm (2'x2') ground plane excluding cable loss

Typical Efficiency - WiFi Elements\*



\* Efficiency modelled for 4x4 MiMo Wifi version with CST Microwave Studio with antenna mounted on 600x600mm (2'x2') ground plane and ignores cable losses

Typical Swept Peak Gain - WiFi Elements\*

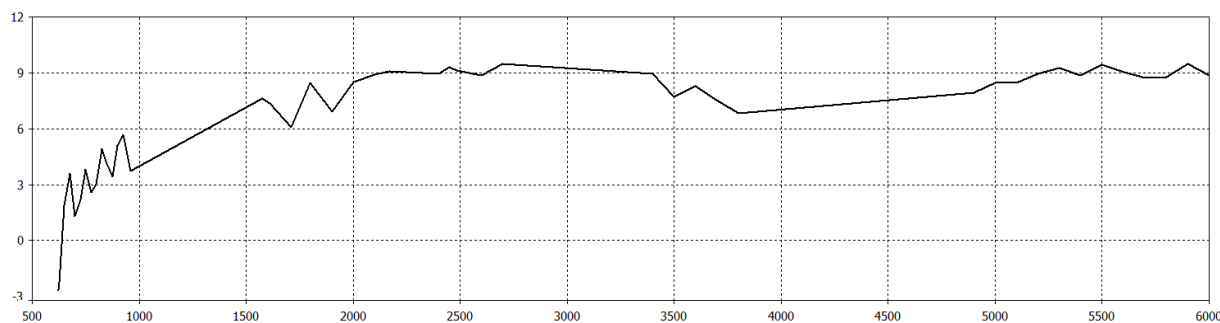

\*Swept peak gain modelled with one element fed in CST Microwave Studio on a 600x600mm (2'x2') ground plane excluding cable loss

# 4x4 MiMo 4G/5G Dome Combination Antenna Range

L[G]M[X]M4[X]-6-60-[24-58]

## 4G/5G Pattern Data

Typical 3D Pattern LTE Elements Side 617MHz

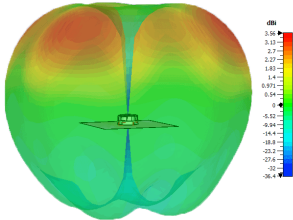

Typical 3D Pattern - LTE Elements Top 617MHz

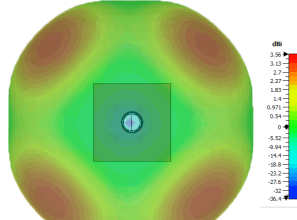

Typical 3D Pattern LTE Elements Side 700MHz

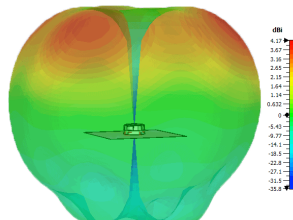

Typical 3D Pattern LTE Elements Top 700MHz

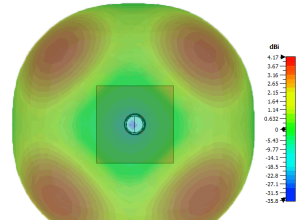

Typical 3D Pattern LTE Elements Side 800MHz

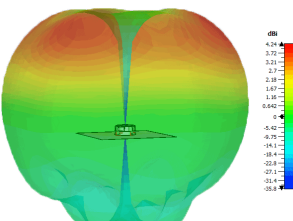

Typical 3D Pattern - LTE Elements Top 800MHz

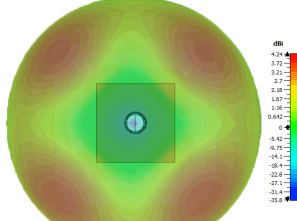

Typical 3D Pattern LTE Elements Side 1800MHz

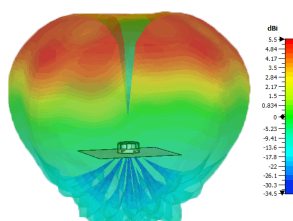

Typical 3D Pattern LTE Elements Top 1800MHz

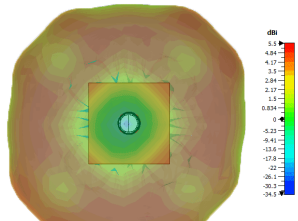

Typical 3D Pattern LTE Elements Side 2100MHz

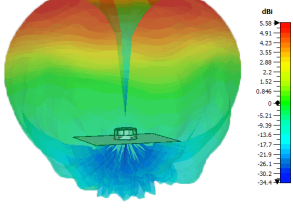

Typical 3D Pattern - LTE Elements Top 2100MHz

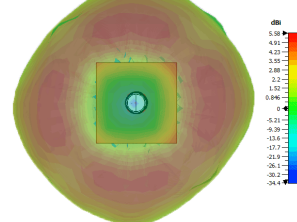

Typical 3D Pattern LTE Elements Side 2600MHz

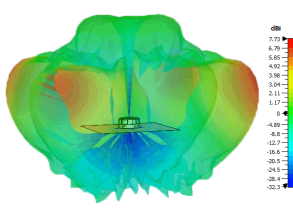

Typical 3D Pattern LTE Elements Top 2600MHz

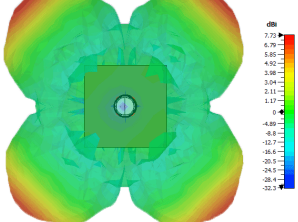

Typical 3D Pattern LTE Elements Side 3600MHz

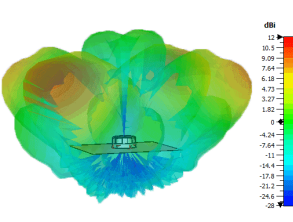

Typical 3D Pattern - LTE Elements Top 3600MHz

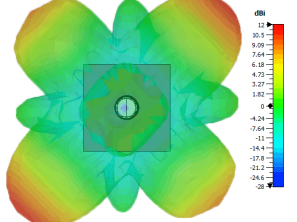

Typical 3D Pattern LTE Elements Side 5400MHz

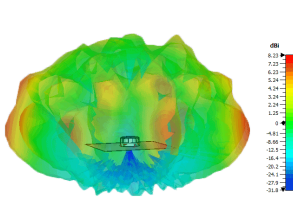

Typical 3D Pattern LTE Elements Top 5400MHz

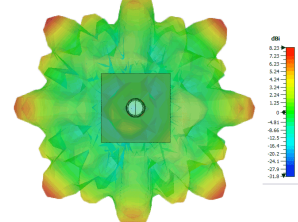

\*Patterns are LGMQM4-6-60-24-58 modelled in CST Microwave Studio on a 600x600mm(2'x2') ground plane with all elements of each type fed.

## WiFi Pattern Data

Typical 3D Pattern WiFi Elements Side 2450MHz

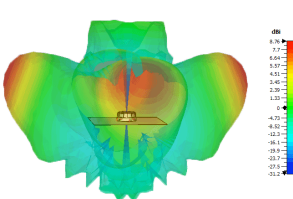

Typical 3D Pattern - WiFi Elements Top 2450MHz

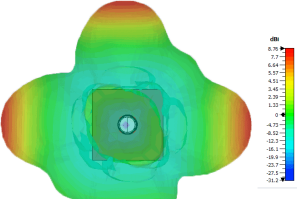

Typical 3D Pattern WiFi Elements Side 5400MHz

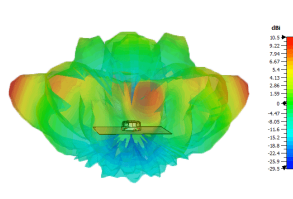

Typical 3D Pattern WiFi Elements Top 5400MHz

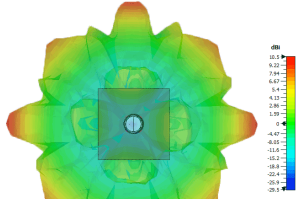

\*Patterns are LGMQM4-6-60-24-58 modelled in CST Microwave Studio on a 600x600mm(2'x2') ground plane with all elements of each type fed.