

# 4G/5G Sharkfin MiMo Antenna SHKG[W]-6-60[-VAR]

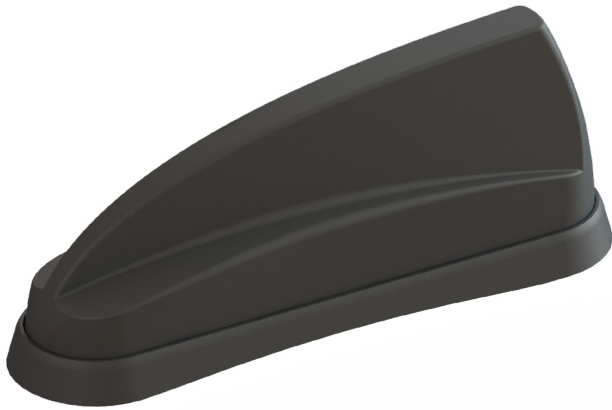

- OEM style sharkfin with 2x2 MiMo for 4G/5G
- Optional GPS/GNSS with Advanced Filtering
- Up to 4x MiMo WiFi

The SHKG 'Sharkee' range has become a byword for industry leading technology in a discrete OEM sharkfin housing. The SHKG-6-60 brings 5G capability to the product family.

The antenna can be fitted on a metallic or non-metallic panel and still offer similar performance.

The OEM style shark fin housing contains a 2x2 MiMo antenna function for 4G/5G (617-960/1710-6000MHz) and option of 2x2, 3x3 or 4x4 MiMo dual band WiFi, which supports WiFi 6. An active antenna for GPS/GLONASS/Galileo/BeiDou is included, with 26dB gain LNA and advanced filtering for LTE Band 13/14 operation.

The SHKG shark fin style design provides multiple antenna functions while remaining discreet and is suitable for public safety (overt/covert), industrial and transport applications where a cost effective, efficient and robust antenna is essential. Requiring only a single hole mounting, the SHKG reduces vehicle damage, installation time & cost and visual impact whilst protecting a vehicle's resale value.

## Technical Drawing

SHKG-6-60-QW Shown

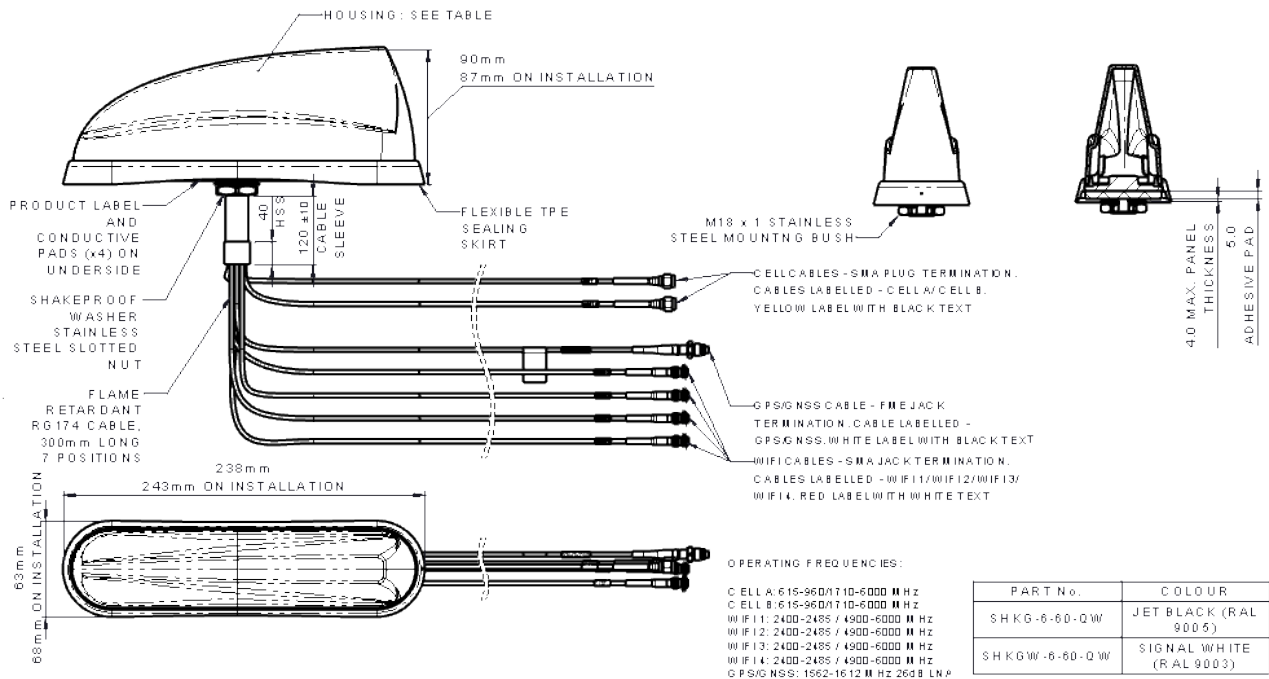

# 4G/5G Sharkfin MiMo Antenna

## SHKG[W]-6-60[-VAR]

### Product Data

Part No.		SHKG[W]-6-60-QW	SHKG[W]-6-60-TW	SHKG[W]-6-60-DW	SHKG[W]-6-60
<b>Electrical Data</b>					
Frequency Range (MHz)	Element 1	1562-1612			
	Elements 2 & 3	2x 617-960, 1710-6000			
	Elements 4, 5 & 6 & 7	4 x 2.4/5.0/7.1GHz	3 x 2.4/5.0/7.1GHz	2 x 2.4/5.0/7.1GHz	-
Peak gain: Isotropic*	Elements 2 & 3	5dBi (617-960MHz)			
	Elements 2 & 3	8dBi (1710-3800MHz)			
	Elements 2 & 3	9dBi (4900-6000MHz)			
Isolation**	4G/5G	>12dB			
	WiFi	> 15dB	> 15dB	> 15dB	-
Typical Efficiency* w/o Cable Loss	Elements 2 & 3	> 40% (617-698MHz) >60% (698-960/1710-6000MHz)			
Correlation Co-efficient	Elements 2 & 3	<0.2			
Polarisation	Vertical				
Pattern	Omni-directional				
Impedance	50Ω				
Max Input Power (W)	10				
<b>GPS/GNSS Data</b>					
Frequency Range (MHz)	1562-1612				
VSWR	<2:1				
Gain: LNA	26dB				
Polarisation	Right Hand Circular				
Out of Band Rejection	>40dB (+/- 100MHz f)   Notch Filter @787MHz - 23dB				
Operating Voltage	3-5V DC (fed via coax)				
Current	<20mA				
<b>Mechanical Data</b>					
Dimensions (mm) - Installed	Total Height	90 (3.54")			
	Length	243 (9.56")			
	Width	63 (2.48")			
Operating Temp (°C)	-40° / +80°C (-40° / 176°F)				
Material	ASA, Silicone Rubber, Aluminium Alloy				
Colour	Black or White (SHKGW part numbers)				
Weight (g)					
Ingress Protection	IP66				
<b>Mounting Info</b>					
Fixing	Panel Mount				
Hole Size (mm)	19 (3/4")				
<b>Cable Data</b>					
Cable Type - All Feeds	FR RG174 (UN ECE R 118 Compliant)				
Dimensions (mm)	Diameter	2.8 (0.11")			
	Length	300 mm (12")			
	GPS/GNSS	FME (f)			
	4G/5G	2 x SMA plug			
WiFi	4x SMA (f)	3x SMA (f)	2x SMA (f)	-	

\*Peak gain and efficiency simulated in CST Microwave Studio on 600x600mm (2'x2') ground plane and exclude cable loss.

\*\* Isolation measured on a 600x600mm (2'x2') ground plane with 5m (16') of CS32 cable and excludes cable loss.

Electrical Data on  
Ground Plane - Cell

Typical VSWR\*

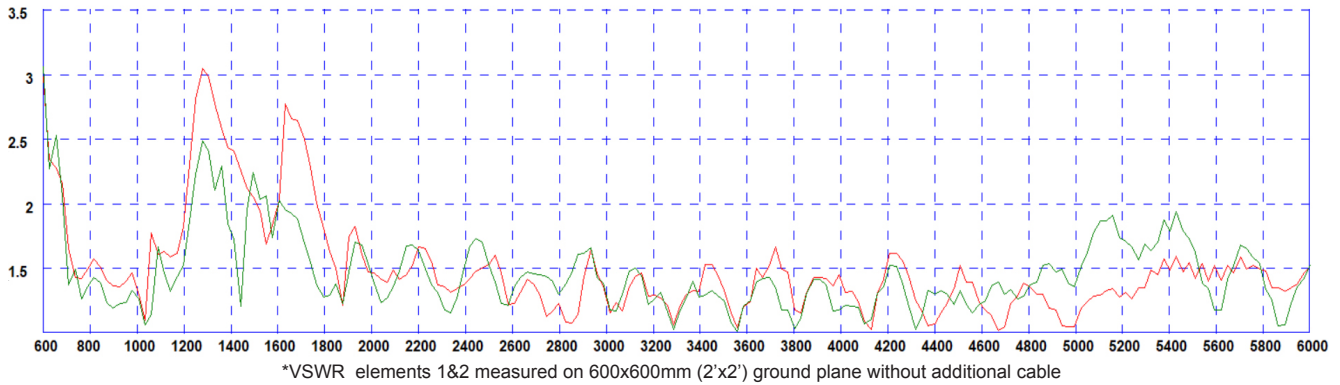

Typical Swept Peak Gain \*\*

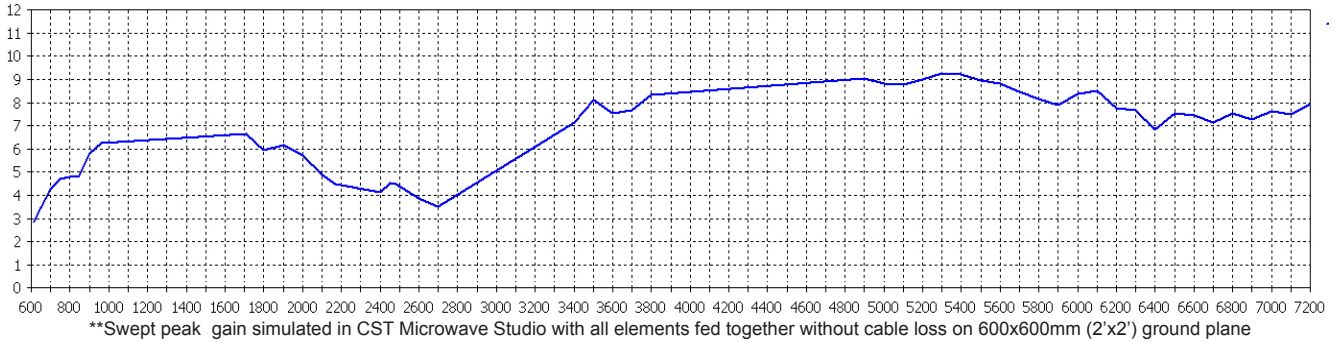

Typical Efficiency \*\*\*

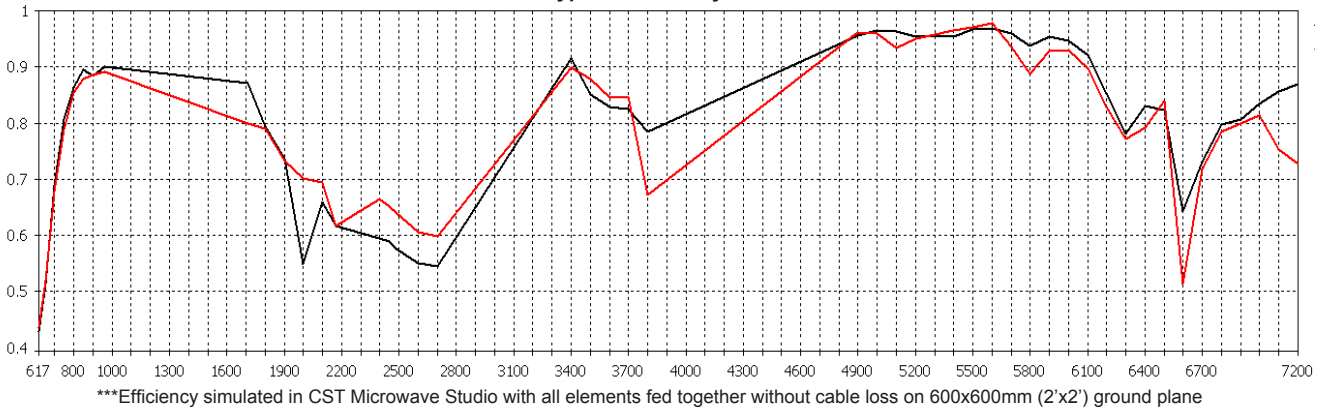

Typical Isolation \*\*\*

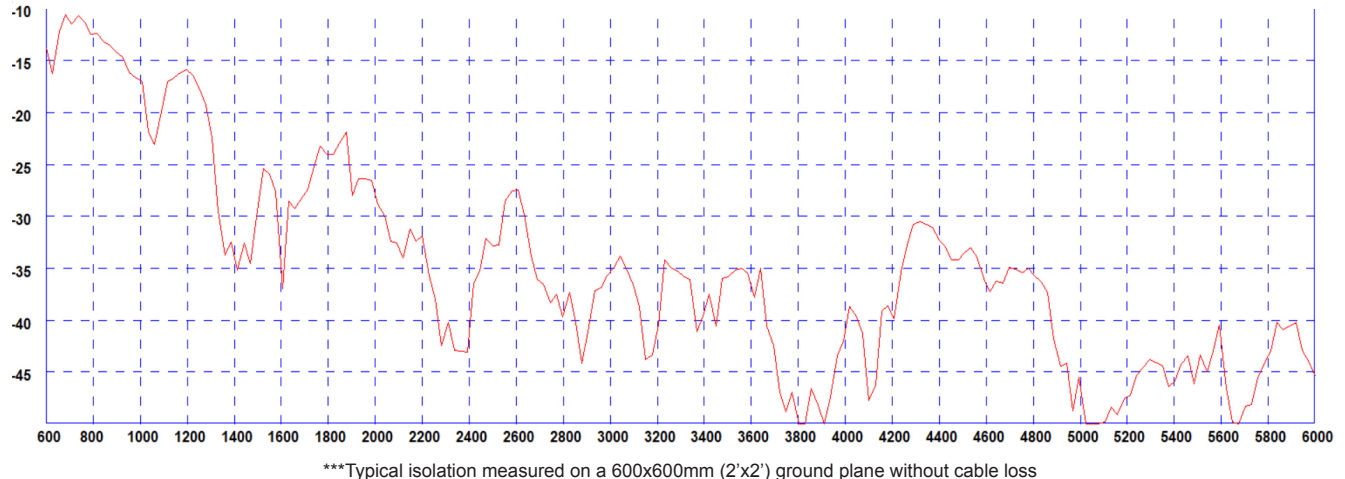

# 4G/5G Sharkfin MiMo Antenna

SHKG[W]-6-60[-VAR]

Electrical Data -on  
groundplane - WiFi

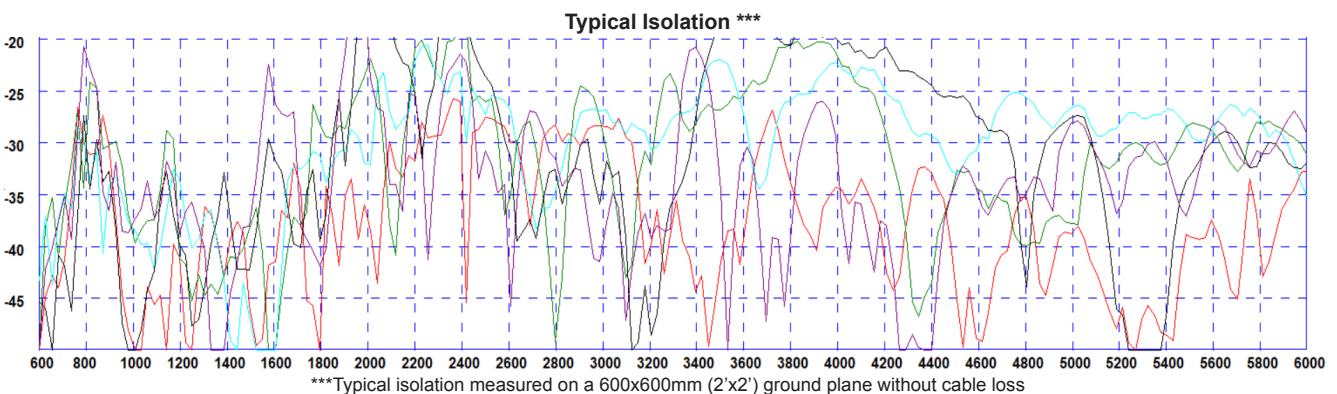
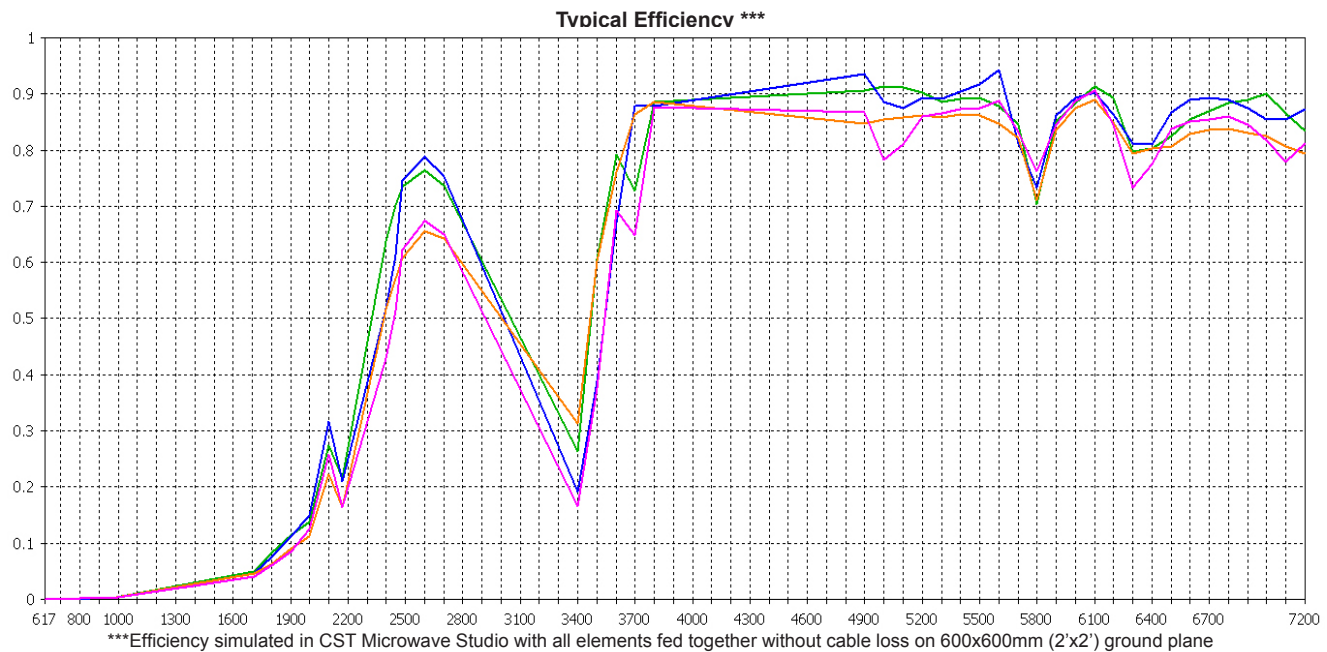
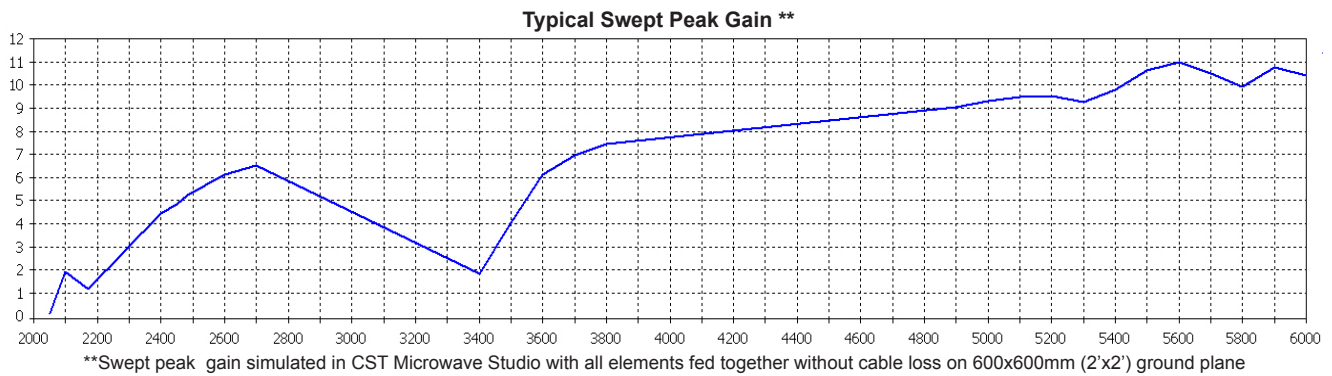
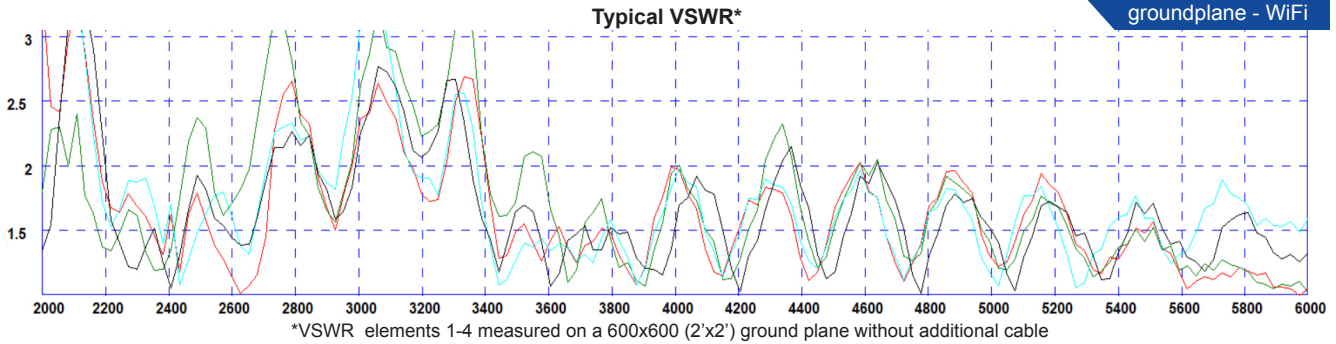

Electrical Data in  
Free Space - Cell

Typical VSWR\*

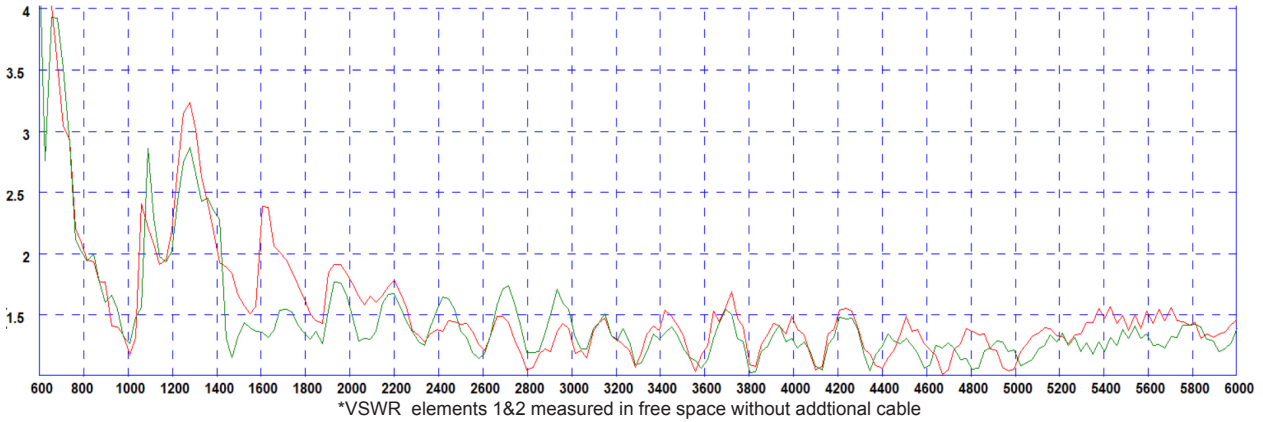

Typical Swept Peak Gain \*\*

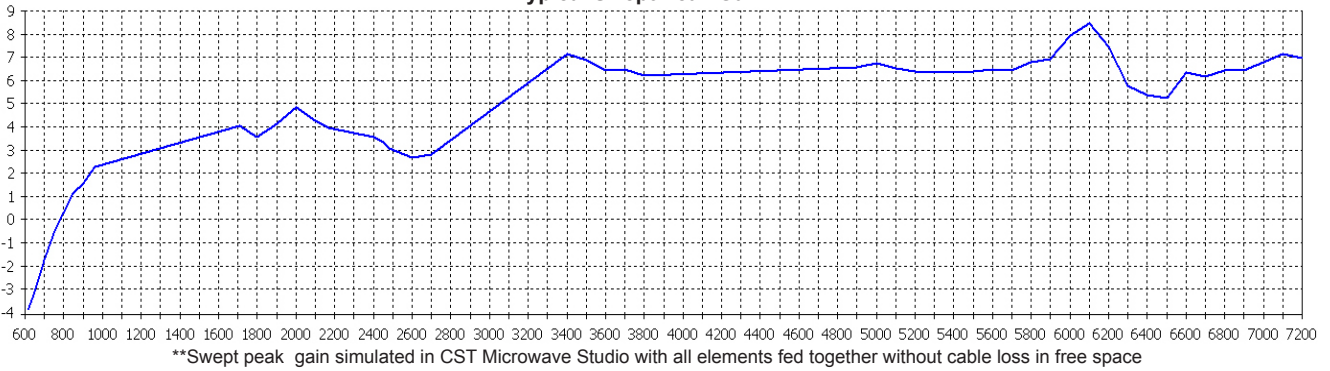

Typical Efficiency \*\*\*

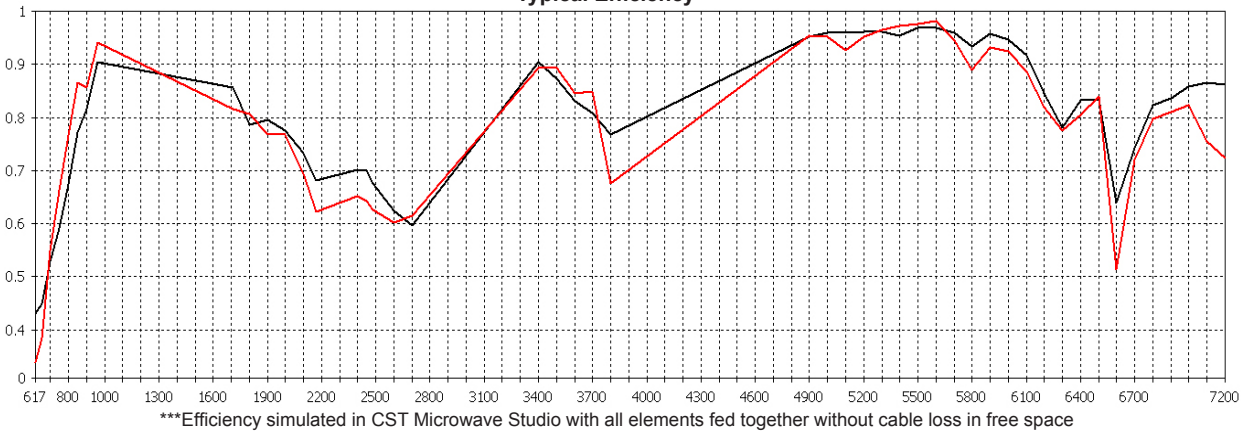

Typical Isolation \*\*\*



# 4G/5G Sharkfin MiMo Antenna

SHKG[W]-6-60[-VAR]

Electrical Data -in  
Free Space - WiFi

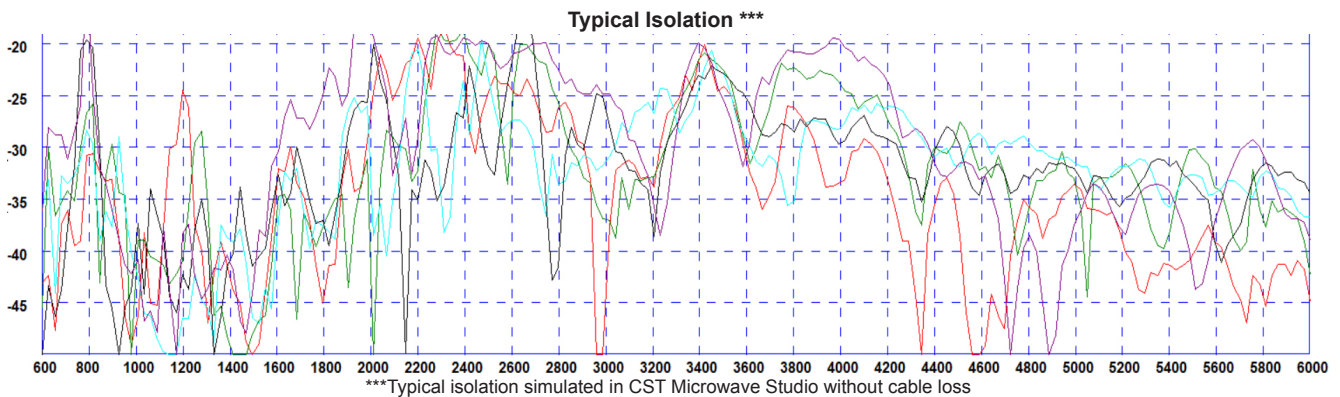
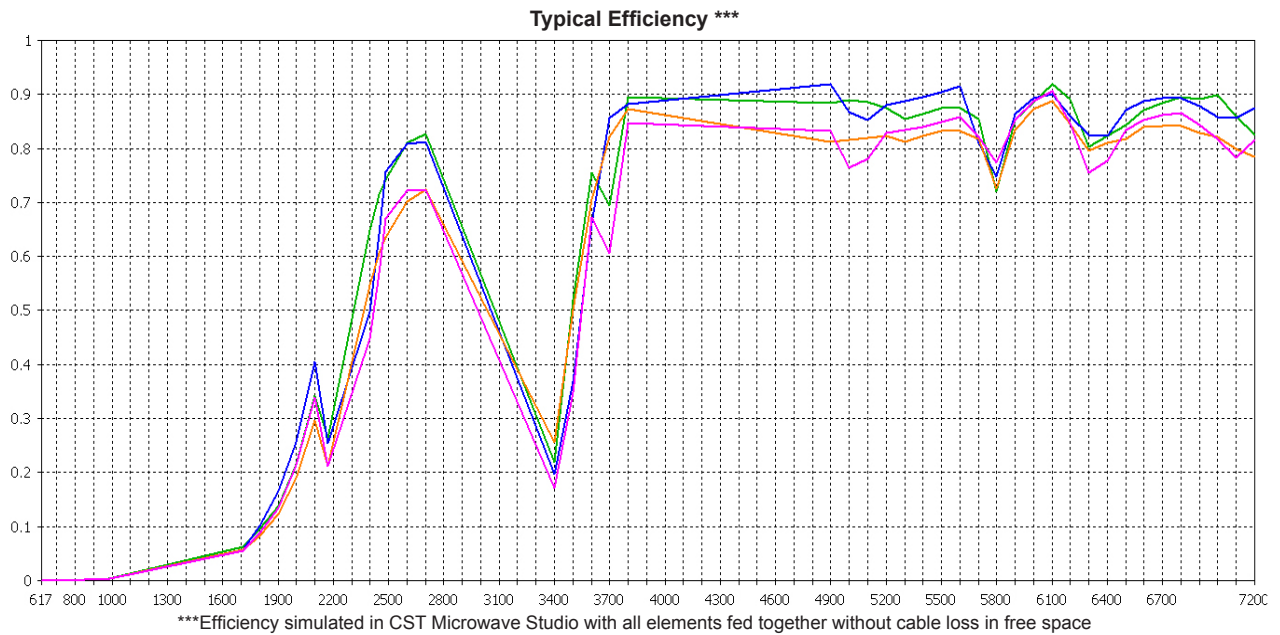
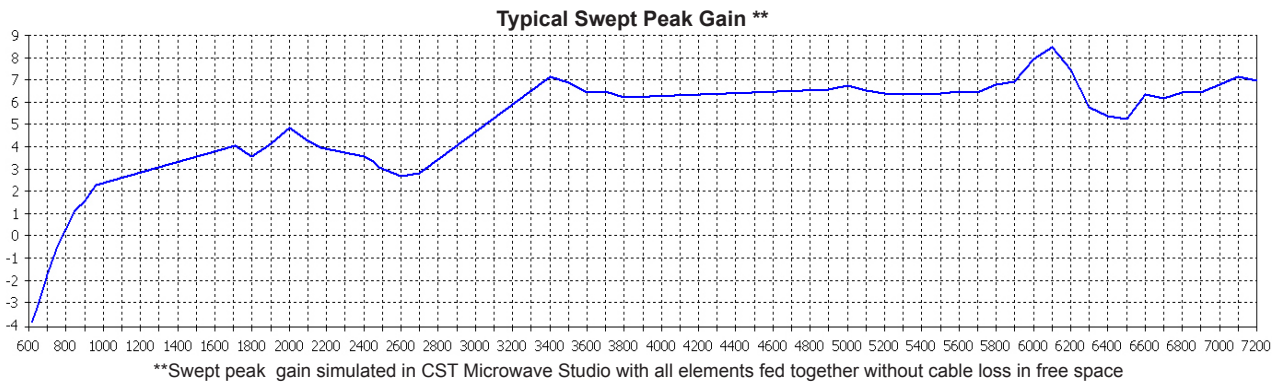
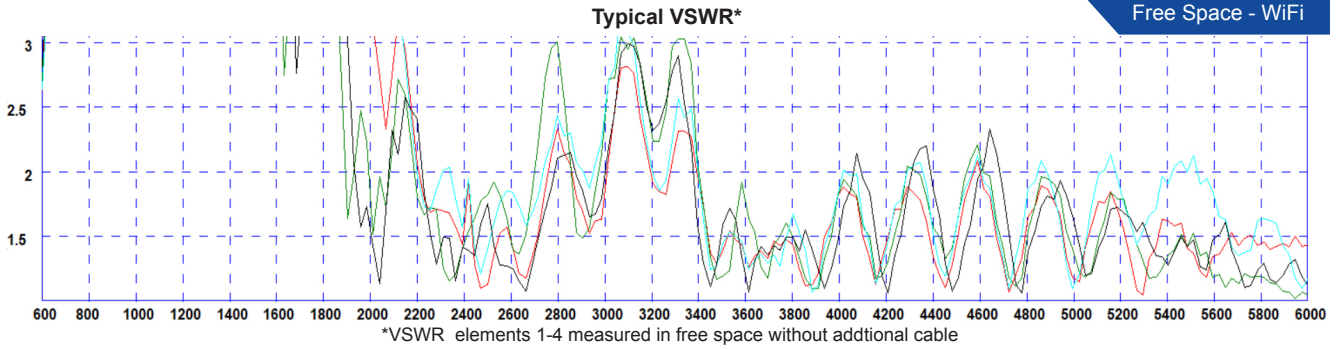

## 3D Patterns on Ground Plane -Cell

3D Pattern All Elements (650MHz)

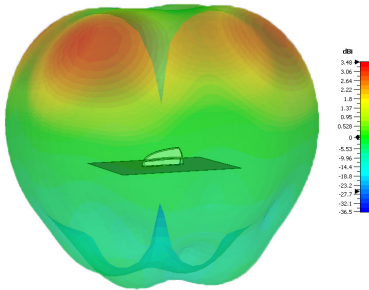

3D Pattern All Elements (750MHz)

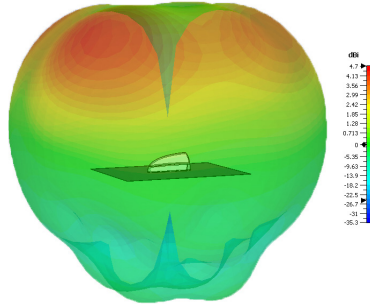

3D Pattern All Elements (850MHz)

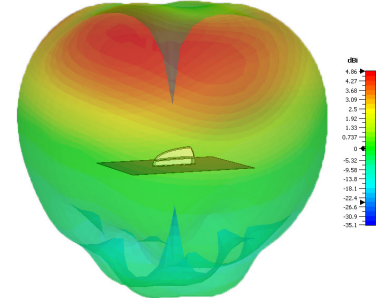

3D Pattern All Elements (1800MHz)

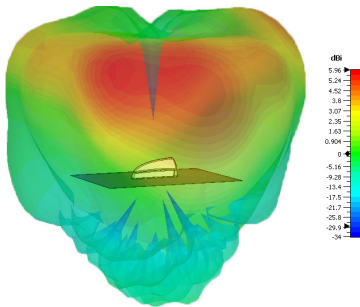

3D Pattern All Elements (2000MHz)

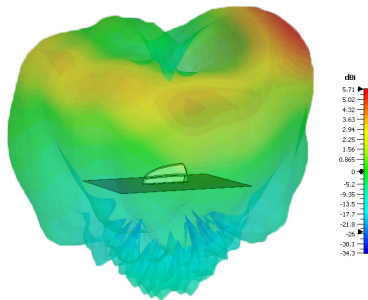

3D Pattern All Elements (2600MHz)

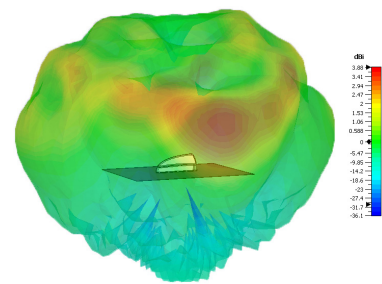

3D Pattern All Elements (3600MHz)

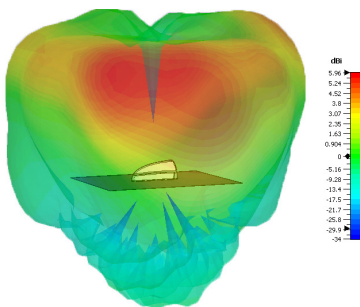

3D Pattern All Elements (5400MHz)

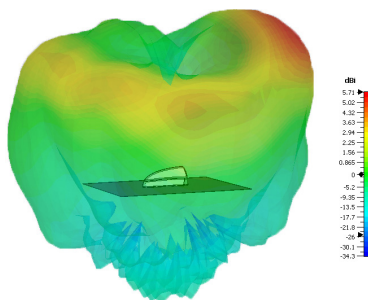

## 3D Patterns on Ground Plane -WIFI

3D Pattern All WiFi Elements (2450MHz)

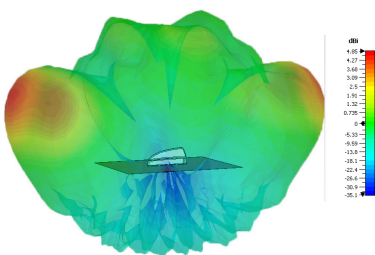

3D Pattern All WiFi Elements (5400MHz)

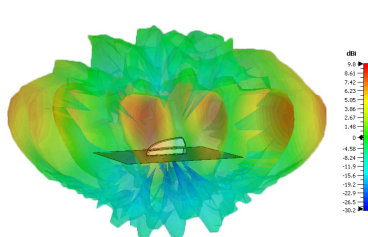

3D Pattern All WiFi Elements (7100MHz)

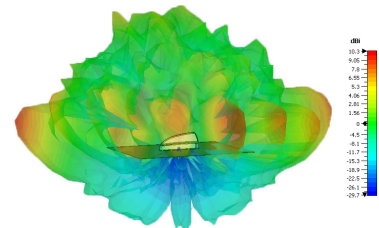

3D patterns all simulated in CST Microwave Studio with all elements of same type fed together excluding cable loss

Electrical Data -in  
Free Space - Cell

3D Pattern All Elements (650MHz)

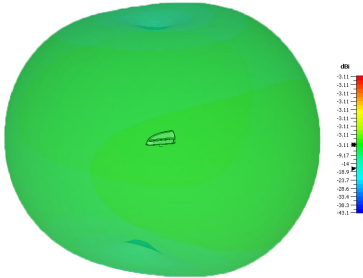

3D Pattern All Elements (750MHz)



3D Pattern All Elements (850MHz)

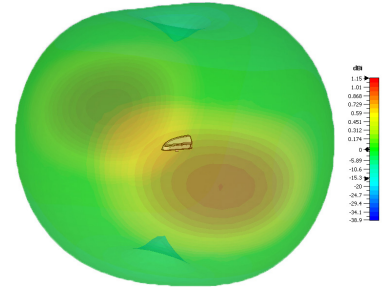

3D Pattern All Elements (1800MHz)

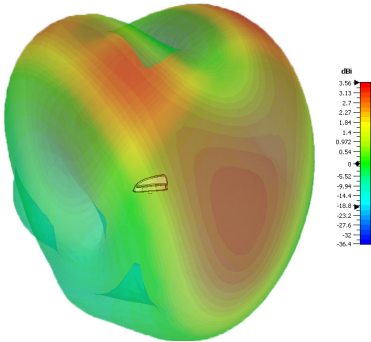

3D Pattern All Elements (2000MHz)

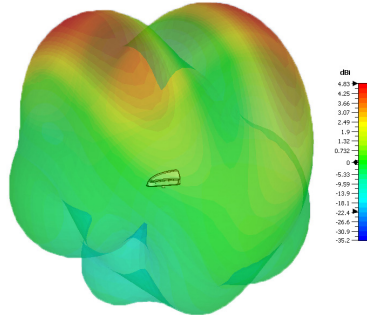

3D Pattern All Elements (2600MHz)

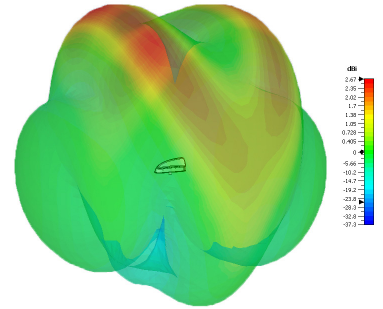

3D Pattern All Elements (3600MHz)

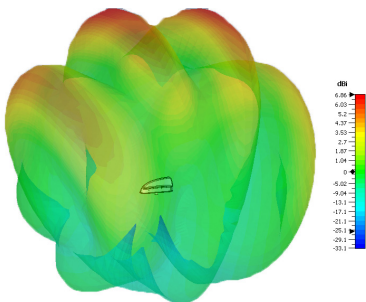

3D Pattern All Elements (5400MHz)

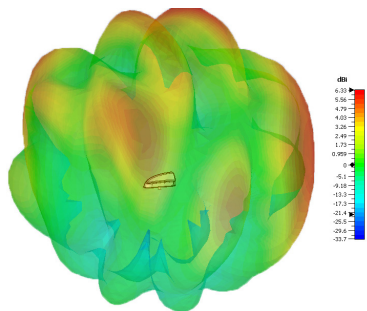

Electrical Data -in  
Free Space - WiFi

3D Pattern All WiFi Elements (2450MHz)

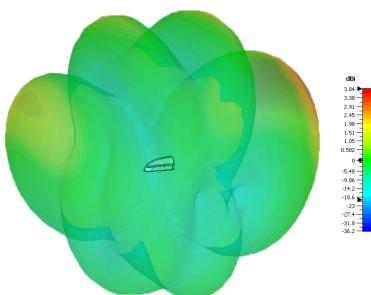

3D Pattern All WiFi Elements (5400MHz)

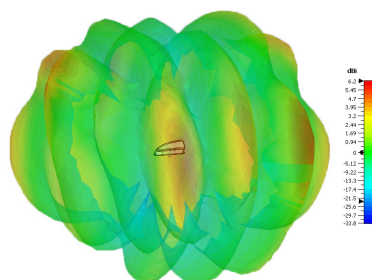

3D Pattern All WiFi Elements (7100MHz)

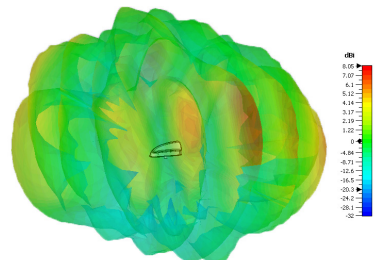

3D patterns all simulated in CST Microwave Studio with all elements of same type fed together excluding cable loss