

ANTENNAS | MIMO-3-V2-15

5 - IN - 1 TRANSPORTATION & AUTOMOTIVE ANTENNA

2X2 LTE (MIMO), 2X2 DUALBAND WIFI (MIMO), GPS/GLONASS

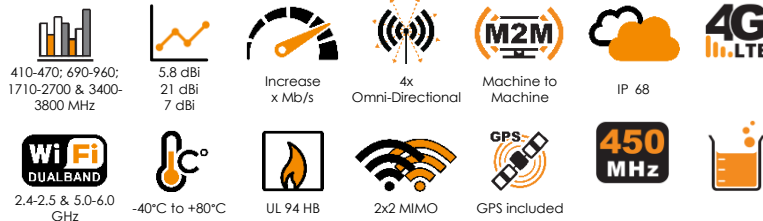

- **5-in-1 high performance multi frequency 2G/3G/4G/LTE antenna (5G Ready)**
- **2 x MiMo LTE, 2 x MiMo WIFI & GPS / GLONASS**
- **Ultra-Wideband, includes 450MHz and 3.5GHz CBRS Bands**
- **Robust and water resistant (IP68) antenna**
- **Ideal for transportation & marine use**
- **Multi mounting options for easy installation**

Product Overview

The MIMO-3-V2-15 consists of a 5-in-1 antenna system within a single housing, providing 2x Cellular, 2x Wi-Fi and a GPS/GLONASS. This antenna is specifically designed for the transportation and marine industry. The 2x Cellular MIMO antennas (for 2G/3G/4G) covers the contemporary 690MHz to 2700MHz bands, as well as the new emerging LTE and 5G spectrum for 450MHz and 3.5GHz CBRS bands, which is becoming popular across the various international cellular network operators for LTE. This antenna, due to its wide band capabilities, can be used across different operators and technologies and is ready for future cellular technologies such as 5G up to 3.8GHz. The antenna provides two separate dual-band Wi-Fi antennas, providing concurrent 2.4GHz and 5GHz on each antenna with 2x2 MIMO capability. The fifth antenna is a high-performance active GPS/GLONASS system operating down to -40 degrees. The antenna exceeds the performance of most competitors due to the attention to the design of this high-performance antenna. The radiation patterns of all radiating elements provide an excellent balance between omnidirectionality, pattern diversity and good radiation abilities at the desired elevation, which is important for this type of antenna, especially for the transportation and marine market. Main applications are for commercial/industrial vehicles, marine, M2M and other IoT systems using a wide range of radio technologies, while remaining futureproof over the wide frequency band offered by this antenna.

Features

- Ultra-wideband 410MHz to 470MHz, 690MHz to 2700MHz and 3400MHz to 3800MHz bands
- Cleverly designed decorrelated antennas give superior MIMO performance in both Wi-Fi (dual band) and cellular bands
- Above features maintained from 698MHz to 5800MHz in relevant bands, including the 450MHz band
- Careful mechanical design provides ruggedness, corrosion, water, dust resistance (IP68)

Application Areas

- Transport broadband and Wi-Fi distribution, automation and telemetry for Busses, Utility, Trucking & Public Safety vehicles
- Industrial factory automation, robotic machinery and other M2M systems telemetry
- Farming & Agricultural automation such as M2M & IoT
- Broadband cellular to WiFi distribution for Marine / Boats (inland and near coastal vessels)
- Mining Vehicles & Machinery communications, telemetry and automation (M2M & IoT)



Frequency Bands – Cellular & Wi-Fi

The MIMO-3-V2-15 is suitable for the following Cellular frequency bands | 410-470 MHz | 690-960 MHz | 1710-2170 MHz | 2300-2500 MHz | 2500-2700 MHz | 3400-3800 MHz | and the following Wi-Fi frequency bands | 2400-2500 MHz | 5000-6000 MHz |

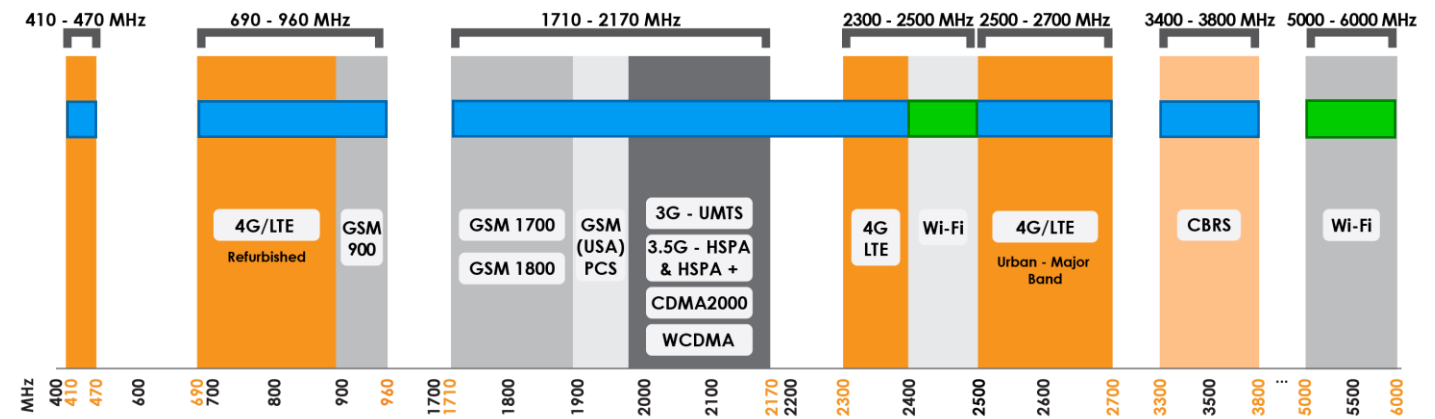

■ Indicates the frequency bands which MIMO-3-V2-15 supports ■ Indicates the frequency bands which MIMO-3-V2-15 supports

Antenna Overview

Ports	1 & 2	3 & 4	5
SISO / MIMO	2x2 MIMO	2x2 MIMO	N/A
Frequency Bands	410 MHz - 3800 MHz	2.4 - 2.5 & 5-6 GHz,	1575.42 MHz/1600 MHz
Peak Gain	5.8 dBi	7 dBi	21 dBi
Coax Cable Type	Twin HDF-195	Twin HDF-195	RTK-031
Coax Cable Length	2m	2m	2m
Connector Type	SMA Male	SMA Male	SMA Male

Electrical Specifications - Cellular

Frequency bands:	410-470 MHz 690-960 MHz 1710-2700 MHz 3400-3800 MHz
Gain (max) Port 1 & 2:	5.8 dBi
VSWR Port 1 & 2:	≤2.5:1
Feed power handling:	10 W
Input impedance:	50 Ohm (nominal)
Polarisation:	Linear Vertical 0.35 dB/m @ 900 MHz 0.53 dB/m @ 2000 MHz 0.6 dB/m @ 2500 MHz 0.72 dB/m @ 3500 MHz
Coax cable loss:	
Path to Ground:	Yes

GPS/Glonass Antenna Electrical Specifications

Frequency Range (GPS):	1575.42MHz/1600MHz
Gain (Max):	21+/-2dBi
VSWR:	≤1.5:1
DC Voltage:	2.7-3.3 V
DC Current:	5-15mA
Noise Figure:	≤1.5 dB
Nominal Impedance:	50 Ω
Polarisation:	RHCP
Filter Out Band Attenuation:	12dB Min f0+50MHz, 16dBi Min f0-50MHz
Cable:	0.04m Micro Cable 1.13
Connector:	SMA male
Voltage:	2.7 - 3.3V
Max. Power-W:	50

Wi-Fi Electrical Specifications

Frequency:	2400-2500 MHz 5000-6000 MHz
Gain (Max):	7 dBi
VSWR:	≤2.5:1 over 95% of the band
Feed power handling:	10 W
Nominal input impedance:	50 Ohm (nominal)
Polarisation:	2 x Vertical linear 0.6 dB/m @ 2500 MHz 0.72 dB/m @ 3500 MHz 0.981 dB/m @ 5800 MHz
Coax cable loss:	
Path to Ground:	Yes

Coax Cable & Connector Type - Cellular & Wi-Fi

Cable length:	2m ±5%
Coax cable type:	Twin HDF 195
Connector type:	SMA (Male)

Coax Cable & Connector Type - GPS

Cable length:	2m ±5%
Coax cable type:	RTK-031
Connector type:	SMA (Male)

*The coax cables & connectors are factory mounted to the antenna

Product Box Contents

Antenna:	A-MIMO-0003-V2-15
Mounting bracket:	Threaded Spigots (Up to 60mm clamping thickness), Adhesive Surface Mounting & Optional Magnetic Mount
Adapters:	RPSMA(m) To SMA (f)

Ordering Information

Commercial name:	MIMO-3-V2-15
Order product code:	A-MIMO-0003-V2-15
EAN number:	0707273470263

Mechanical Specifications

Product dimensions	253 mm x 128 mm x 144 mm
Packaged dimensions:	265 mm x 211 mm x 204 mm
Weight:	1.36 kg
Packaged weight:	1.46 kg
Radome material:	UV Stable SAN Marine ASA
Radome colour:	Brilliant White, Pantone P 179-1 C
Mounting Type:	Spigot, Surface with Magnetic mount option

Environmental Specifications, Certification & Approvals

Wind Survival:	<220 km/h
Temperature Range (Operating):	-40°C to +80°C
Environmental Conditions:	Outdoor/Indoor
Water ingress protection ratio/standard:	IP 68
Salt Spray:	MIL-STD 810F/ASTM B117
Operating Relative Humidity:	Up to 98%
Storage Humidity:	5% to 95% - non-condensing
Storage Temperature:	-40°C to +80°C
Flammability Rating:	UL 94-HB, ECE-R118.02 Certified cables
Impact resistance:	IK 10
Product Safety & Environmental:	Complies with CE, EN, CSA, RoHS and IEC standards



Technical Drawings

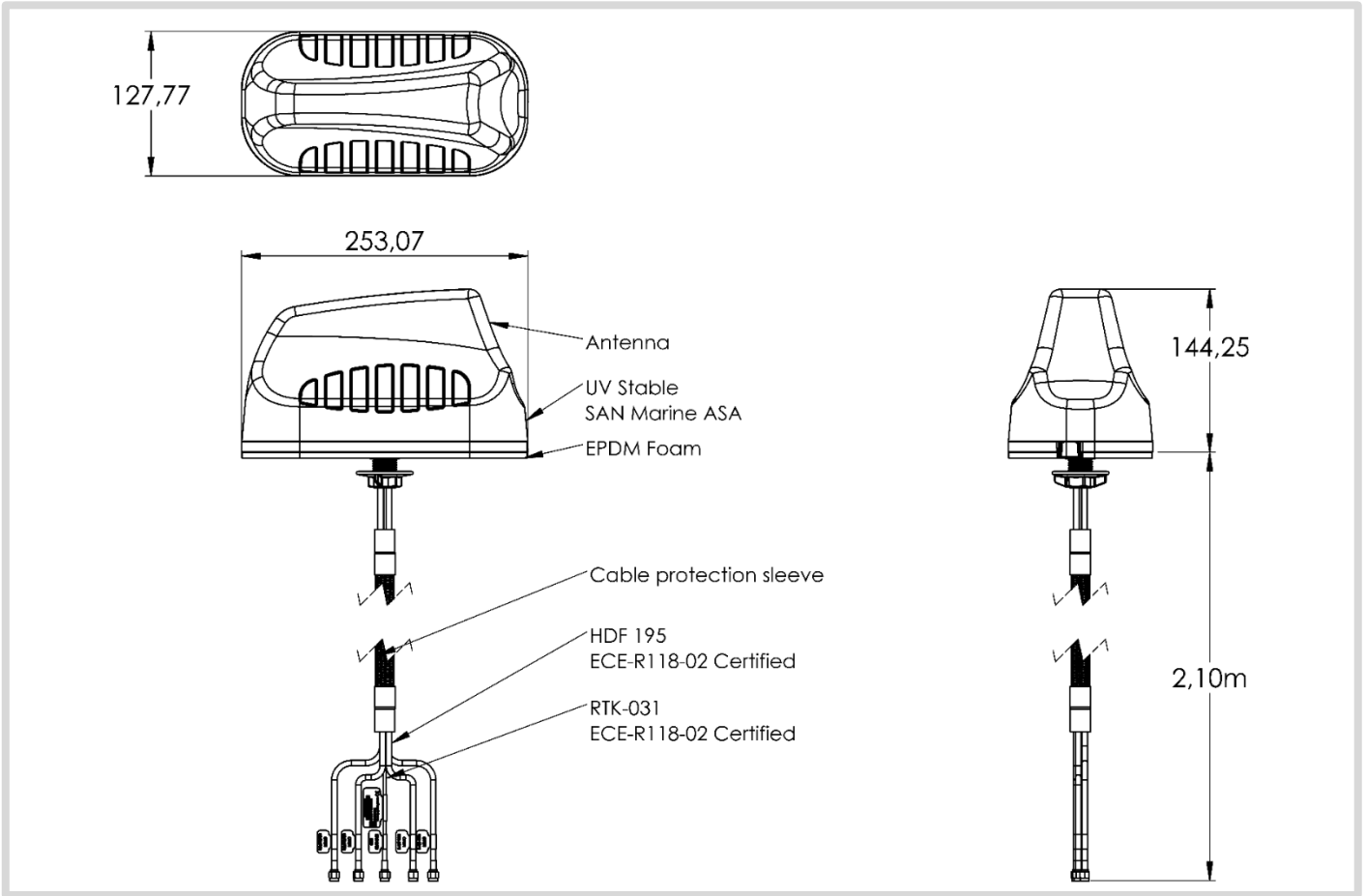

Antenna Performance Plots

VSWR: Cellular Antenna

Gain: Cellular Antenna

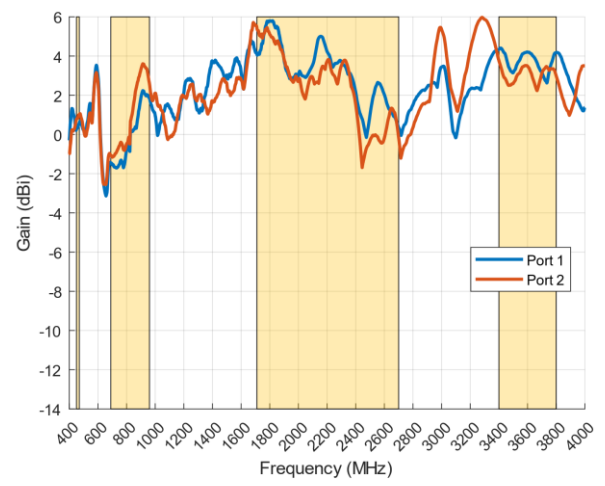
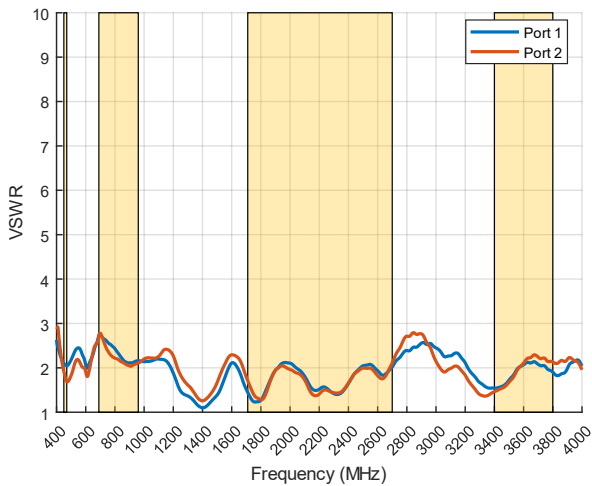

Voltage Standing Wave Ratio (VSWR)*

VSWR is a measure of how efficiently radio-frequency power is transmitted from a power source, through a transmission line, into a load. In an ideal system, 100% of the energy is transmitted which corresponds to a VSWR of 1:1.

The MIMO-3-V2-15 delivers superior performance across all bands with a VSWR of $\leq 2.5:1$

*Measured with 2m low loss cable

Gain in dBi

5.8 dBi is the peak gain across all bands from 410-470, 690-960 1710-2700 & 3400-3800 MHz

VSWR: Wi-Fi Antenna

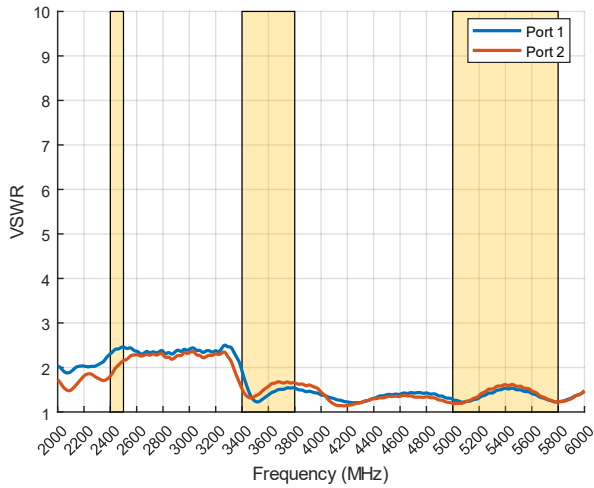

Gain: Wi-Fi Antenna

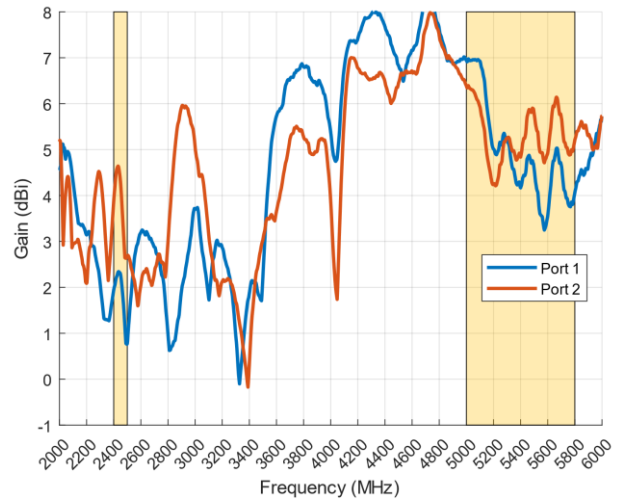

Voltage Standing Wave Ratio (VSWR)*

VSWR is a measure of how efficiently radio-frequency power is transmitted from a power source, through a transmission line, into a load. In an ideal system, 100% of the energy is transmitted which corresponds to a VSWR of 1:1.

The MIMO-3-V2-15 delivers superior performance across all bands with a VSWR of $\leq 2.5:1$ over 95% of the band

*Measured with 2m low loss cable

Gain in dBi

7 dBi is the peak gain across all bands from 2400-2500 & 5000 – 6000 MHz

Radiation Patterns – Cellular

Azimuth (Top View): 410–470 MHz

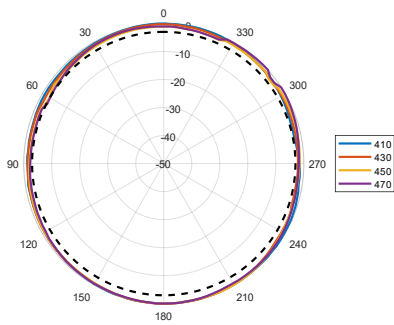

Azimuth (Top View): 690–960 MHz

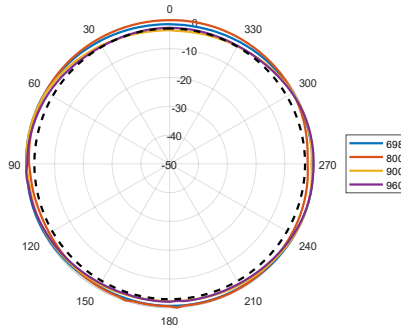

Azimuth (Top View): 1710–2100 MHz

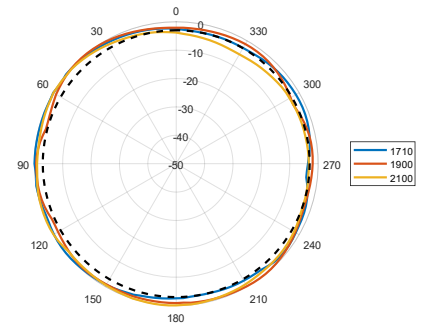

Azimuth (Top View): 2300–2700 MHz

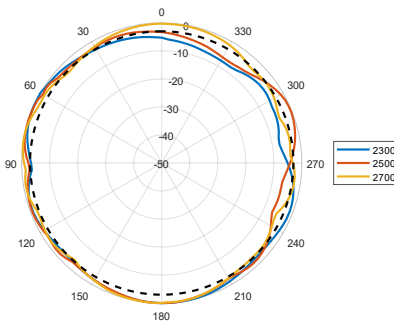

Azimuth (Top View): 3400–3800 MHz

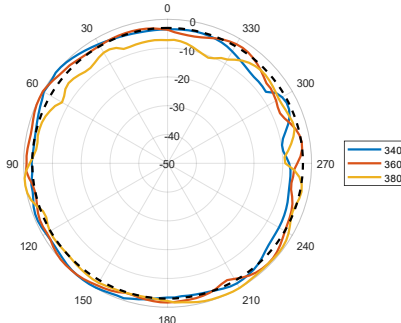

Elevation (Side View): 410–470 MHz

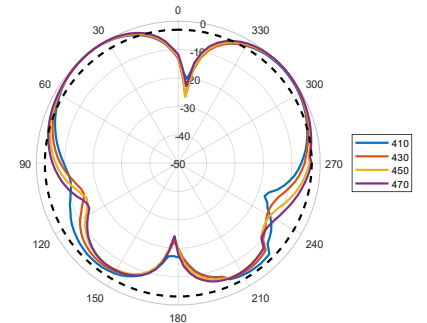

Elevation1 (Side View): 690-960 MHz

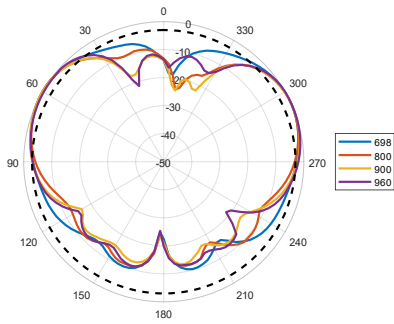

Elevation1 (Side View): 1710-2100 MHz

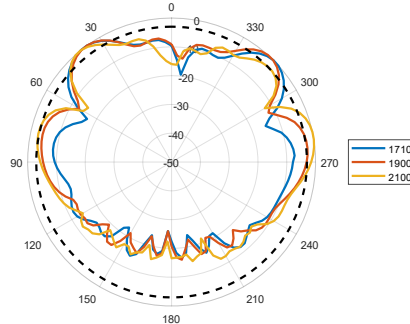

Elevation1 (Side View): 2300-2700 MHz

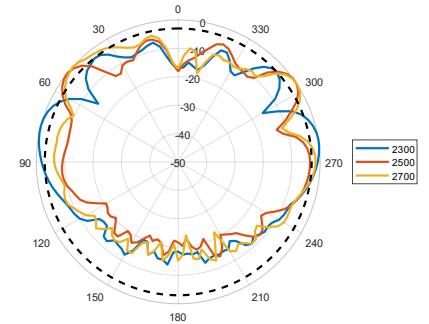

Elevation1 (Side View): 3400-3800 MHz

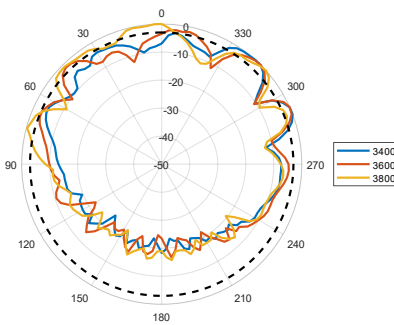

Elevation2 (Side View): 410-470 MHz

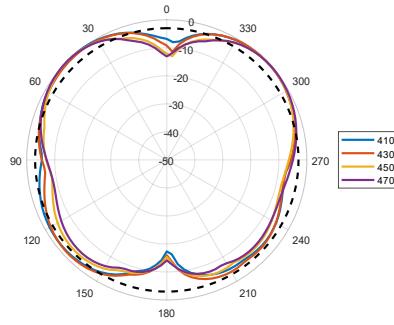

Elevation2 (Side View): 690-960 MHz

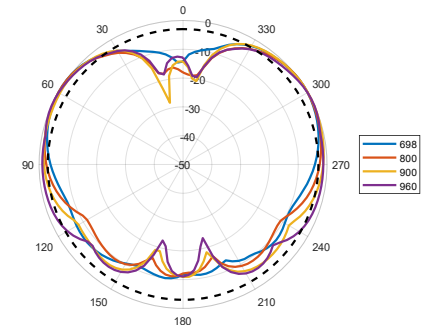

Elevation2 (Side View): 1710-2100 MHz

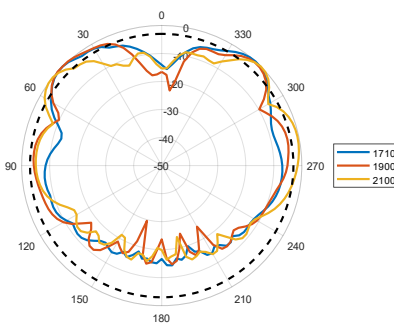

Elevation2 (Side View): 2300-2700 MHz

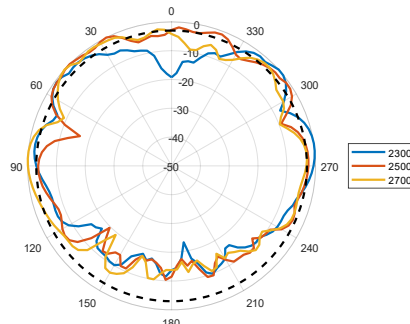

Elevation2 (Side View): 3400-3800 MHz

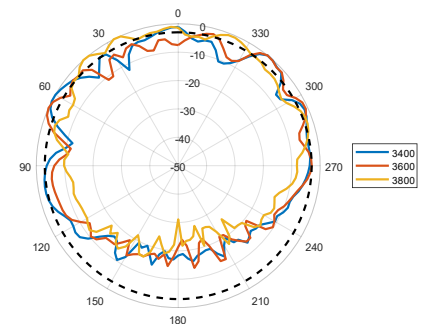

Radiation Patterns – WiFi

Azimuth (Top View): 2400-2500 MHz

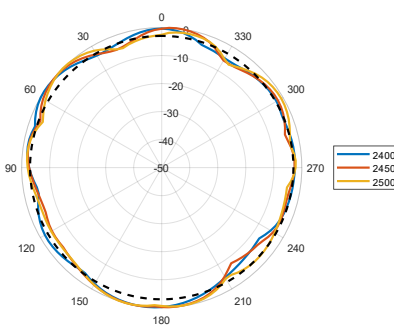

Azimuth (Top View): 5000-5400 MHz

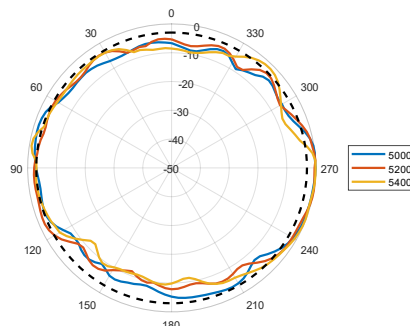

Azimuth (Top View): 5600-5800 MHz

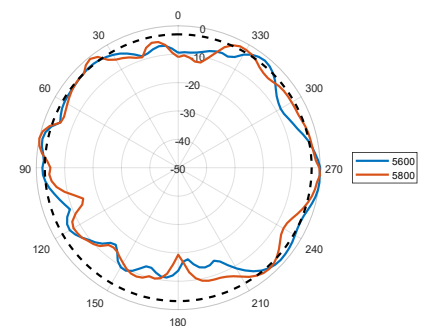

Elevation1 (Side View): 2400-2500 MHz

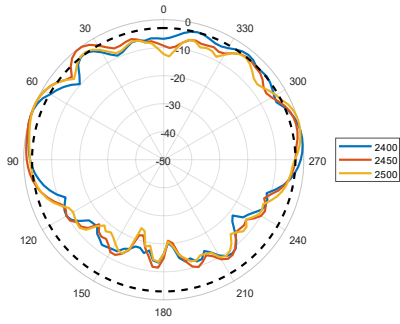

Elevation1 (Side View): 5000-5400 MHz

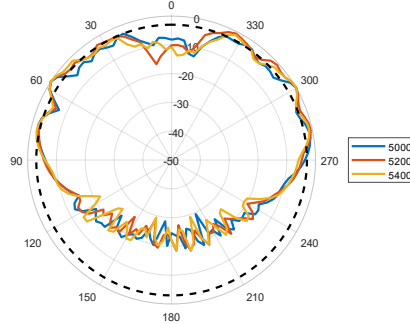

Elevation (Side View): 5600-5800 MHz

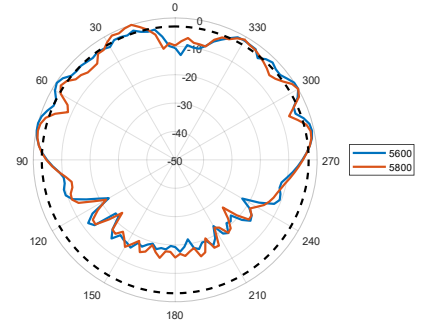

Elevation2 (Side View): 2400-2500 MHz

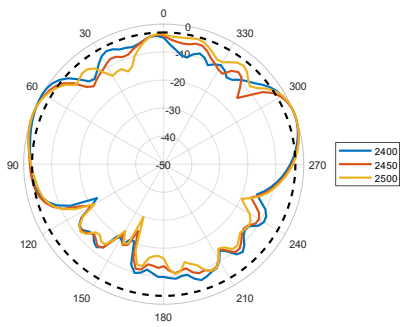

Elevation2 (Side View): 5000-5400 MHz

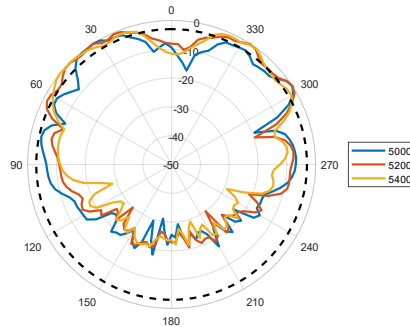

Elevation2 (Side View): 5600-5800 MHz

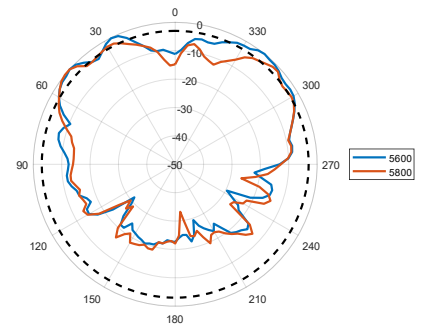

Radiation Patterns – GPS

XY Plane: 1561-1602 MHz

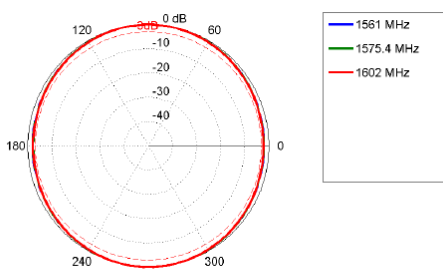

XZ Plane: 1561-1602 MHz

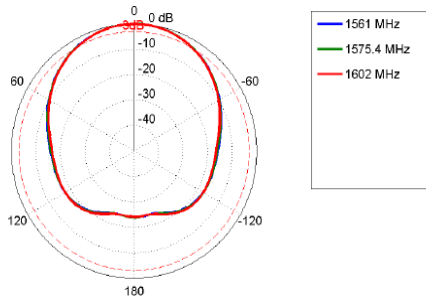

YZ Plane: 1561-1602 MHz

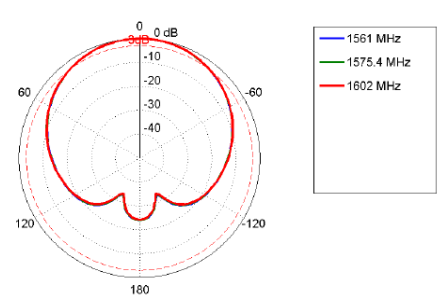

Mounting Options

Standard Spigot Mount

Threaded Spigot Mounting

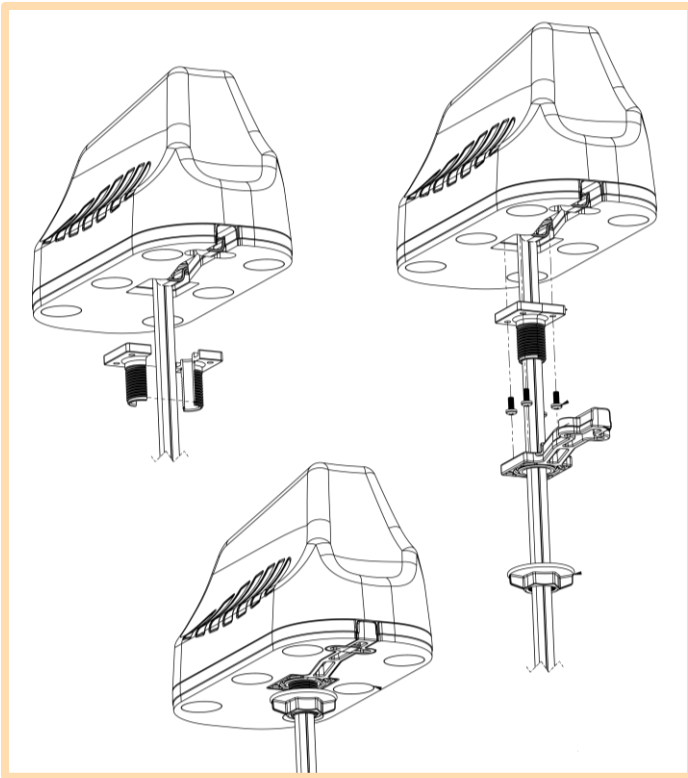

Surface Mount

Adhesive Surface Mounting

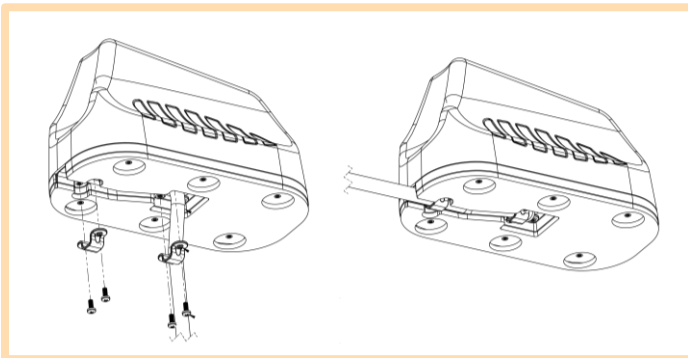

Magnetic Mount

Optional Magnetic Base Kit

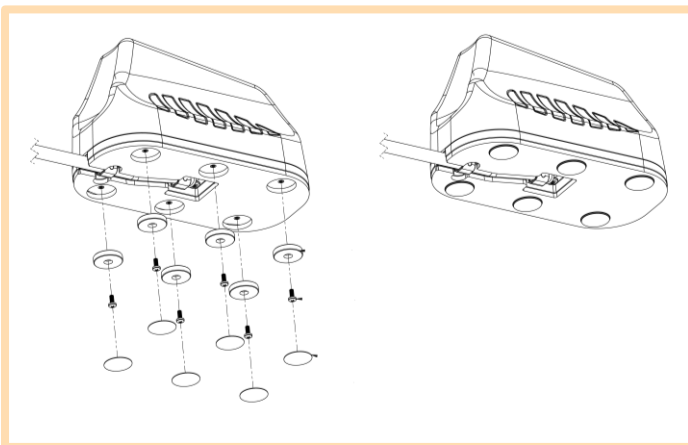

Additional Accessories



A-MBK-0001-V1.0

Magnetic Base Kit



A-CAB-118

5 x 5m Extension cables for 5-in-1 Antennas



A-CAB-119

5 x 3m Extension cables for 5-in-1 Antennas

Contact Poynting

Poynting Antennas (Pty) Ltd - Head Office

Unit 4, N1 Industrial Park
Landmarks Avenue,
Samrand, 0157
South Africa

Phone: +27 (0) 12 657 0050

E-mail: sales@poynting.co.za

Poynting Europe

Regus Business Center Neue Messe Riem
Kronstadter Straße 4
81677 München
Germany

Phone: +49 89 208026538

E-mail: sales-europe@poynting.tech