



# ShowUP Digital Signage Player

## Quick users guide

ShowUP digital signage player powered by Beabloo is a perfect tool to give more visibility to your products, engage your customers, promote new services. ShowUP creates 360° marketing campaigns with a single click and publish in few seconds, update your social networks and digital signage screens with the latest offers and news about your business.

## ShowUP Digital Signage Player

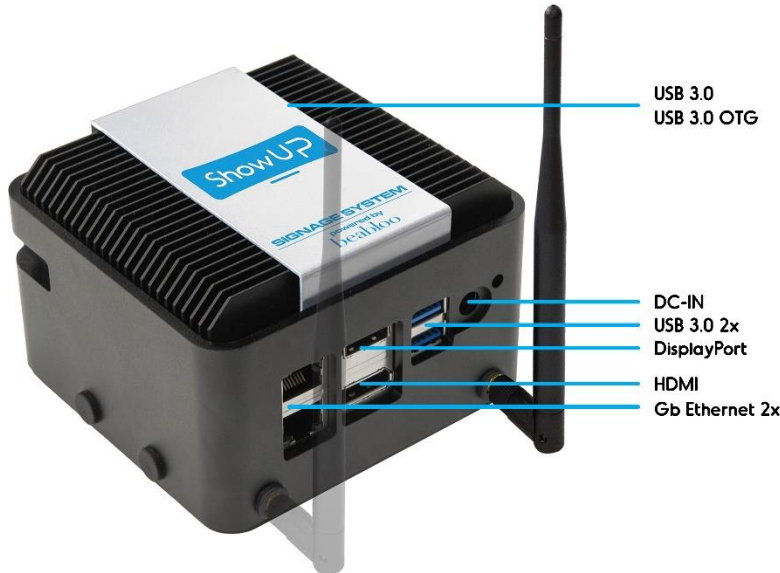

## What's in your kit



Show UP Digital Signage Player



Power supply

You'll need the following, not included:

- A monitor with either HDMI or DisplayPort
- USB keyboard and mouse
- Ethernet cable

For more information about your UP board, software, accessories and peripherals, please visit [www.up-community.org](http://www.up-community.org)

### 1 Connect

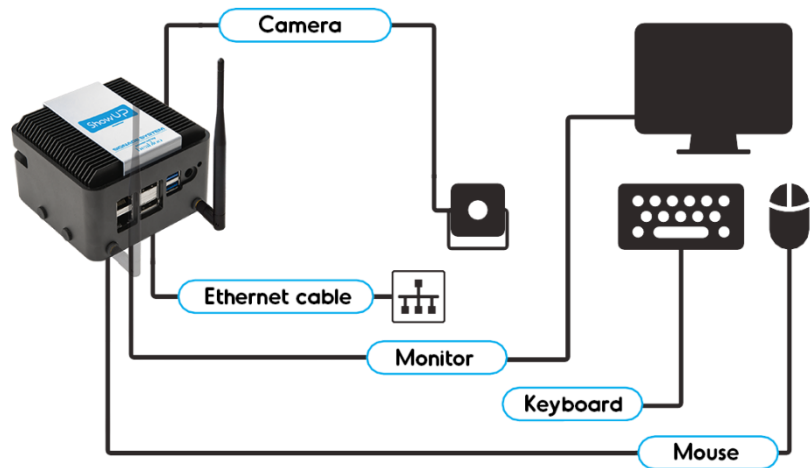

### 2 Get started

#### 1 Connect the player to the screen.

Plug the player into the charger. Connect the player's HDMI cable to your screen\*.



\*Please make sure you have the correct auxiliary HDMI channel.

- With an Ethernet cable and a router.



- With Wi-Fi.

Connect a **USB keyboard** to the player and press **p+ENTER**. Within the menu, select **Network Settings > WiFi Wizard > Configure a new connection**. Select your Wi-Fi network and enter your Wi-Fi password.



#### 3 Publish content to the screen with ShowUP.

Access **ShowUP** with your credentials and create your own content. If you have not received your credentials yet, contact [showup@up-board.org](mailto:showup@up-board.org).



#### 2 Connect the player to the Internet.

There are **two** ways to connect a player to the Internet.

### Check the Video Tutorial For ShowUP Platform Configuration

- Set your business information: <https://www.youtube.com/watch?v=D9nOWhhe3a4>  
This video explains you how to set your business information in ShowUP signage.
- Platform configuration: <https://www.youtube.com/watch?v=q6kBBBaTtg8>  
This video explains you
  - a. How to publish content on your website?
  - b. How to push content from emails?
  - c. How to set the approval for the content publication?



# ShowUP Digital Signage Player



















## Quick users guide

## Safety Precautions

Please read the following safety instructions carefully. It is advised that you keep this manual for future references

1. All cautions and warnings on the device should be noted.
2. Make sure the power source matches the power rating of the device.
3. Position the power cord so that people cannot step on it. Do not place anything over the power cord.
4. Always completely disconnect the power before working on the system's hardware.
5. No connections should be made when the system is powered as a sudden rush of power may damage sensitive electronic components.
6. If the device is not to be used for a long time, disconnect it from the power supply to avoid damage by transient over-voltage.
7. Always disconnect this device from any power supply before cleaning.
8. While cleaning, use a damp cloth instead of liquid or spray detergents.
9. Make sure the device is installed near a power outlet and is easily accessible.
10. Keep this device away from humidity.
11. Place the device on a solid surface during installation to prevent falls.
12. Do not cover the openings on the device to ensure optimal heat dissipation.
13. Watch out for high temperatures when the system is running.
14. Do not touch the heat sink or heat spreader when the system is running
15. Never pour any liquid into the openings. This could cause fire or electric shock.
16. As most electronic components are sensitive to static electrical charge, be sure to ground yourself to prevent static charge when installing the internal components. Use a grounding wrist strap and contain all electronic components in any static-shielded containers.
17. If any of the following situations arises, please the contact our service personnel:
  - I. Damaged power cord or plug
  - II. Liquid intrusion to the device
  - III. Exposure to moisture
  - IV. Device is not working as expected or in a manner as described in this manual
  - V. The device is dropped or damaged
  - VI. Any obvious signs of damage displayed on the device
18. **DO NOT LEAVE THIS DEVICE IN AN UNCONTROLLED ENVIRONMENT WITH TEMPERATURES BEYOND THE DEVICE'S PERMITTED STORAGE TEMPERATURES (SEE Following Table) TO PREVENT DAMAGE.**

For more information about your UP board, software, accessories and peripherals, please visit  
[www.up-community.org](http://www.up-community.org)

UP <sup>2</sup> - Specifications			
        	<p><b>SOC</b> Intel® Celeron™ N3350 (up to 2.4 GHz) Intel® Pentium™ N4200 (up to 2.5 GHz) Intel® Atom™ X5-E3940 / X7-E3950</p> <p><b>Graphics</b> Intel® Gen 9 HD, supporting 4K Codec Decode and Encode for HEVC4, H.264, VP8</p> <p><b>Video &amp; Audio</b> HDMI 1.4b x1 4K @ 30 hz + DP 1.2 4K @ 60 hz I2S audio port</p> <p><b>Camera interface</b> MIPI-CSI2 2-lane (2MP) + MIPI-CSI2 4-lane ( 8MP)</p> <p><b>Display interface</b> eDP</p> <p><b>Power</b> 5V DC-in @ 4A-6A</p> <p><b>Operating humidity</b> 0% ~ 90% relative humidity, non-condensing</p> <p><b>Operating Temperature</b> 32-140°F / 0-60°C</p> <p><b>Altera MAX 10 FPGA</b> 2KLE --Celeron/ Pentium 4KLE -- ATOM</p>	        	<p><b>Memory</b> 2GB/4GB/8GB LPDDR4</p> <p><b>Storage Capacity</b> 32 GB / 64 GB / 128 GB eMMC</p> <p><b>USB</b> 3x UB3.0 (Type A) + 1x USB 3.0 OTG (Micro B) 2x USB2.0+2 X UART (Tx/Rx) debug port ( pin header)</p> <p><b>Ethernet</b> 2x Gb Ethernet (full speed, Realtek 8111G) RJ-45</p> <p><b>RTC</b> Yes</p> <p><b>Expansion</b> 40 pin General Purpose bus + 4-channel 12-bit A/D converter (500 ksp/s to 1 Msps) 60 pin EXHAT 1xmini-PCIe (full-size, auto switch to m-SATA) M.2 2230, SATA3</p> <p><b>Compatible Operating system</b> Microsoft Windows 10 (full), Windows IOT Core, Linux (ubilinux, Ubuntu, Yocto), Android Marshmallow</p> <p><b>Dimensions</b> 3.37" x 3.54" / 85.60 mm x 90 mm</p> <p><b>Certificate</b> CE/FCC Class A, RoHS compliant, REACH</p>

## FCC Statement

### Warning!



This device complies with Part 15 FCC Rules. Operation is subject to the following two conditions:  
(1) this device may not cause harmful interference, and (2) this device must accept any interference received including interference that may cause undesired operation.

**Caution:** There is a danger of explosion if the battery is incorrectly replaced. Replace only with the same or equivalent type recommended by the manufacturer. Dispose of used batteries according to the manufacturer's instructions and your local government's recycling or disposal directives.

**Attention:** Il y a un risque d'explosion si la batterie est remplacée de façon incorrecte. Ne la remplacer qu'avec le même modèle ou équivalent recommandé par le constructeur. Recycler les batteries usées en accord avec les instructions du fabricant et les directives gouvernementales de recyclage.

For more information about your UP board, software, accessories and peripherals, please visit  
[www.up-community.org](http://www.up-community.org)

## China RoHS Requirements (CN)

产品中有毒有害物质或元素名称及含量

AAEON Main Board/ Daughter Board/ Backplane

部件名称	有毒有害物质或元素					
	铅 (Pb)	汞 (Hg)	镉 (Cd)	六价铬 (Cr(VI))	多溴联苯 (PBB)	多溴二苯醚 (PBDE)
印刷电路板 及其电子组件	○	○	○	○	○	○
外部信号 连接器及线材	○	○	○	○	○	○
<p>O: 表示该有毒有害物质在该部件所有均质材料中的含量均在 SJ/T 11363-2006 标准规定的限量要求以下。</p> <p>X: 表示该有毒有害物质至少在该部件的某一均质材料中的含量超出 SJ/T 11363-2006 标准规定的限量要求。</p> <p>备注: 此产品所标示之环保使用期限, 系指在一般正常使用状况下。</p>						

## China RoHS Requirements (CN)

Poisonous or Hazardous Substances or Elements in Products

AAEON Main Board/ Daughter Board/ Backplane

Component	Poisonous or Hazardous Substances or Elements					
	Lead (Pb)	Mercury (Hg)	Cadmium (Cd)	Hexavalent Chromium (Cr(VI))	Polybrominated Biphenyls (PBB)	Polybrominated Diphenyl Ethers (PBDE)
PCB & Other Components	○	○	○	○	○	○
Wires & Connectors for External Connections	○	○	○	○	○	○
<p>O: The quantity of poisonous or hazardous substances or elements found in each of the component's parts is below the SJ/T 11363-2006-stipulated requirement.</p> <p>X: The quantity of poisonous or hazardous substances or elements found in at least one of the component's parts is beyond the SJ/T 11363-2006-stipulated requirement.</p> <p><b>Note: The Environment Friendly Use Period as labeled on this product is applicable under normal usage only</b></p>						

For more information about your UP board, software, accessories and peripherals, please visit [www.up-community.org](http://www.up-community.org)