



# EdgePoint™ R8

Intelligent WISP Control  
with FiberProtect™

Model: EP-R8

QUICK START GUIDE



## Introduction

Thank you for purchasing the Ubiquiti Networks® EdgePoint™ Router. This Quick Start Guide is designed to guide you through installation and includes the warranty terms.

## Package Contents



EdgePoint  
Switch



Wall-Mount  
Bracket



Metal Straps  
(Qty. 2)



Cable Sleeve



Cable Ties  
(Qty. 20)



S2 Hex Wrench



Wall-Mount Screws  
(Qty. 4)



Wall-Mount Anchors  
(Qty. 4)



Phillips Bolts  
(Qty. 2)



Gigabit PoE (54V, 1.5A)  
with Mounting Bracket



Power Cord



PoE Screws  
(Qty. 2)



PoE Anchors  
(Qty. 2)



Quick Start  
Guide

## Installation Requirements

- 7 mm socket wrench
- S2 hex wrench
- Ground wire – min. 10 AWG (5 mm<sup>2</sup>) and max. length: 1 m. As a safety precaution, ground the EdgePoint to a grounded mast, pole, tower, or grounding bar.
- Shielded Category 5 (or above) cabling should be used for all wired Ethernet connections and should be grounded through the AC ground of the PoE.
- We recommend that you protect your networks from harmful outdoor environments and destructive ESD events with industrial-grade, shielded Ethernet cable from Ubiquiti Networks. For more details, visit: [www.ubnt.com/toughcable](http://www.ubnt.com/toughcable)

TERMS OF USE: Shielded Ethernet cable and earth grounding must be used as conditions of product warranty. TOUGH Cable™ is designed for outdoor installations. It is the customer's responsibility to follow local country regulations, including operation within legal frequency channels, output power, and Dynamic Frequency Selection (DFS) requirements.

## Hardware Overview

### Bottom Panel Button



Button	Description
Reset	<p>There are two methods to reset the EP-R8 to factory defaults:</p> <p><b>Runtime Reset (Recommended)</b></p> <p>The EP-R8 should be running after bootup is complete. Press and hold the <b>Reset</b> button for about 10 seconds until the <i>eth7</i> or <i>SFP 2</i> LED starts flashing and then becomes solidly lit (the <i>SFP 2</i> LED is used if there is an SFP module connected to the <i>SFP 2</i> port). After a few seconds, the LED will turn off, and the EP-R8 will automatically reboot.</p> <p><b>Power-on Reset</b></p> <ol style="list-style-type: none"> <li>1. Disconnect power from the EP-R8.</li> <li>2. Press and hold the <b>Reset</b> button while connecting power to the EP-R8. Keep holding the button until the <i>eth7</i> or <i>SFP 2</i> LED starts flashing and then stops flashing after a few seconds (the <i>SFP 2</i> LED is used if there is an SFP module connected to the <i>SFP 2</i> port).</li> </ol>

## Bottom Panel Console Port



Interface	Description
Console	<p>RJ45 serial console port for Command Line Interface (CLI) management. Use an RJ45-to-DB9, serial console cable, also known as a rollover cable, to connect the <i>Console</i> port to your computer. (If your computer does not have a DB9 port, then you will also need a DB9 adapter.) Then configure the following settings as needed:</p> <ul style="list-style-type: none"> <li>• <i>Baud rate</i> 115200</li> <li>• <i>Data bits</i> 8</li> <li>• <i>Parity</i> NONE</li> <li>• <i>Stop bits</i> 1</li> <li>• <i>Flow control</i> NONE</li> </ul>



**Note:** Remove the protective plug from the *Console* port before use.

## Power Options

Either the VDC or PoE input type is used at any one time. If both are connected, only the input type with the highest voltage will be used; the other can be used as a backup.

Both PoE inputs can be used at the same time. If there is a voltage difference, the higher-voltage source will be used first. The voltage from the initial source will drop as the load increases. When the voltage drops to the same level as the lower-voltage source, then the lower-voltage source will also start providing power.

### Power Input Options

- 54VDC, 6A
- 54V, 1.5A on *eth0 (PoE In)*
- 54V, 1.5A on *PoE In*

### Power Output Options

- EdgePoint (required)
- Passive 54/24V, 4-Pair PoE on *eth1-eth2*
- Passive 24V, 2-Pair PoE on *eth3-eth7*

The number of devices that can be powered depends on the power consumption of the specific devices. Example: If you use 54VDC, 1.5A, then you have 81W. If the EdgePoint uses 40W, then you have 41W for PoE output. Check product specifications for the power consumption values to use in your calculations.

## Bottom Panel DC Input



Interface	Description
VDC In	Terminal block connector uses auto-polarity detection and accepts +42 to +56VDC, 6A input (including the Ubiquiti EdgePower™, model EP-54V-150W) to power the EdgePoint and passive PoE output. -48V is NOT supported.

## Bottom Panel RJ45 Ports

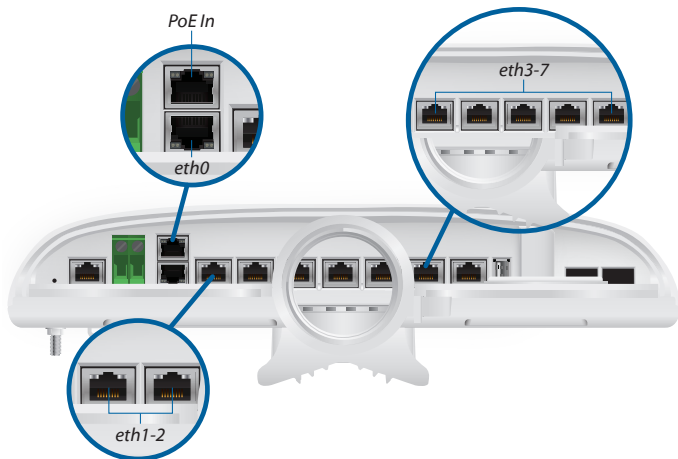

Interface	Description
PoE In	Accepts 54V, 1.5A PoE input from a secondary PoE adapter (not included) to power the EdgePoint and passive PoE output.
PoE In / eth0	Accepts data and 54V, 1.5A PoE input from the included <i>Gigabit PoE Adapter</i> to power the EdgePoint and passive PoE output.
eth1-2 (54/24V PoE Out)	RJ45 ports support 10/100/1000 Ethernet connections and passive 54/24V, 4-pair PoE output for airFiber® devices.
eth3-7 (24V PoE Out)	RJ45 ports support 10/100/1000 Ethernet connections and passive 24V, 2-pair PoE output for airMAX® devices.  RJ45 port <i>eth6</i> or <i>eth7</i> is active only if the corresponding SFP port is empty.



**Note:** The USB port is reserved for future use.

## Bottom Panel SFP Ports

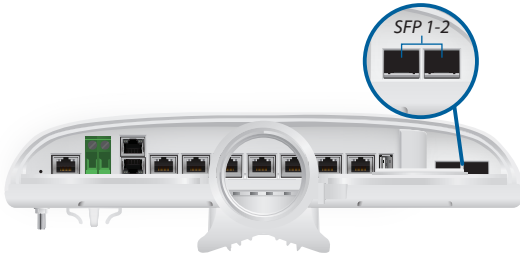

Interface	Description
SFP 1-2	SFP ports are hot-swappable and support 100 Mbps or Gigabit fiber SFP modules. If an SFP module is plugged in, then the SFP port is active, and the corresponding RJ45 port is deactivated.

 **Note:** For extreme temperatures, please use industrial-grade fiber SFP modules.

## Front Panel LEDs

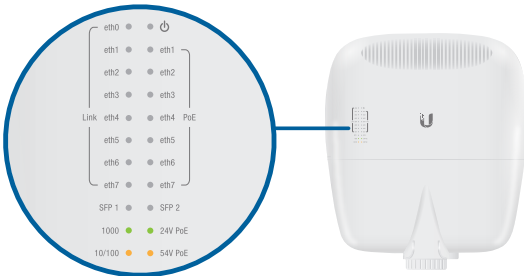

LED	State	Status
eth0	Off	No Link
	Amber	10/100 Mbps Link Flashing Indicates Activity
	Green	1000 Mbps (1 Gbps) Link Flashing Indicates Activity



LED		State	Status
power		Green	EdgePoint Powered On
eth1-2	Speed/ Link/Act	Off	No Link
		Amber	10/100 Mbps Link Flashing Indicates Activity
		Green	1000 Mbps (1 Gbps) Link Flashing Indicates Activity
	PoE Output	Off	No PoE
		Amber	54V, 4-Pair Passive
		Green	24V, 4-Pair Passive
eth3-7	Speed/ Link/Act	Off	No Link
		Amber	10/100 Mbps Link Flashing Indicates Activity
		Green	1000 Mbps (1 Gbps) Link Flashing Indicates Activity
	PoE Output	Off	No PoE
		Green	24V, 2-Pair Passive
	SFP 1-2	Speed/ Link/Act	Off
Amber			100 Mbps Link Flashing Indicates Activity
Green			1000 Mbps (1 Gbps) Link Flashing Indicates Activity

## Back Panel

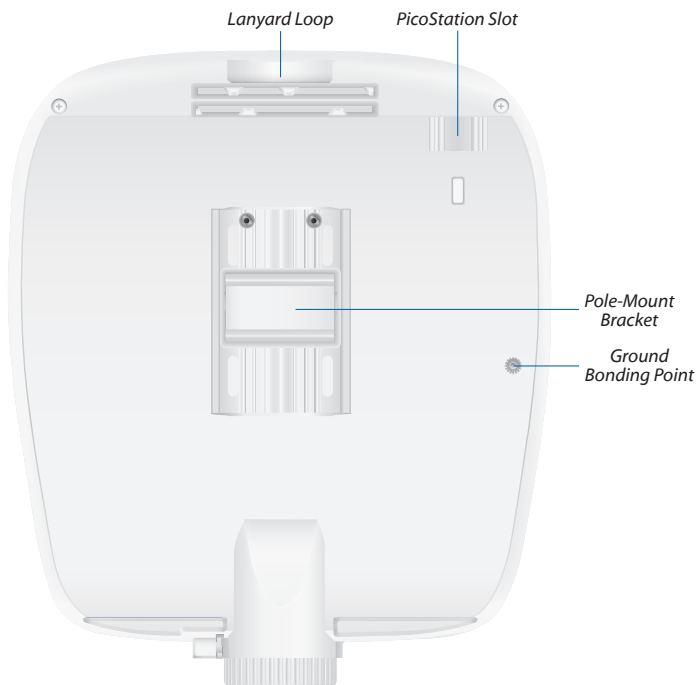

**Lanyard Loop** Used for temporary support during installation.

**PicoStation®M2HP Slot** Used for mounting an optional PicoStationM2HP (not included) to the back of the EdgePoint. (You can use the PicoStationM2HP for wireless management of the EdgePoint.)

**Pole-Mount Bracket** Used for pole-mounting or in combination with the included *Wall-Mount Bracket* for wall-mounting.

**Ground Bonding Point** Used to secure a ground wire (not included).

## Attaching the Cable Sleeve

1. Insert and rotate the coupling to attach the *Cable Sleeve* to the EdgePoint.



**Note:** You have two options for using a 2.0-inch NPT (National Pipe Thread) male conduit (not included):

- Use the conduit instead of the *Cable Sleeve*.
- Use the conduit to extend the *Cable Sleeve*.

## Hardware Installation

You can mount the EdgePoint on a pole or to a wall. Follow the appropriate instructions for your installation method.

### Pole-Mounting

1. Open the two *Metal Straps* and feed them through the mounting slots on the back of the EdgePoint.

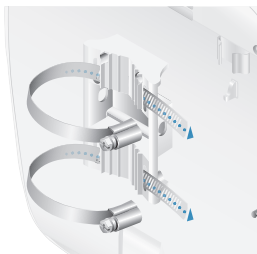

2. Wrap the *Metal Straps* around the pole. Use a 7 mm socket wrench to turn the screws clockwise and securely fasten the straps to the pole.

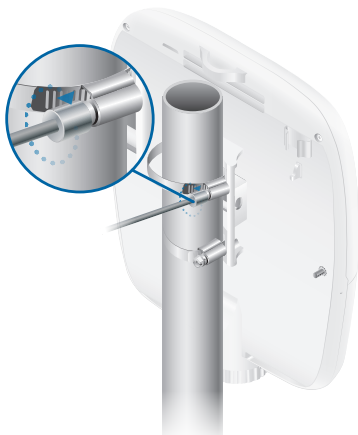

3. Proceed to the *Grounding the EdgePoint* section.

## Wall-Mounting

1. Use the four *Wall-Mount Screws* and *Anchors* to attach the *Wall-Mount Bracket* to the wall.



**Note:** The *Wall-Mount Bracket* must be anchored directly to a stud or other structurally stable surface.

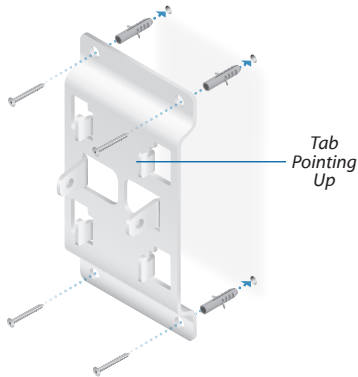

2. Insert the tabs of the *Wall-Mount Bracket* into the slots of the *EdgePoint*. Slide the *EdgePoint* down.



3. Use the two *Phillips Bolts* to attach the EdgePoint to the *Wall-Mount Bracket*.



## Grounding the EdgePoint



**Note:** The ground wire should be as short as possible and no longer than one meter in length.

1. Remove the nut from the *Ground Bonding Point* located on the back of the EdgePoint.



2. Attach a ground wire (min. 10 AWG or 5 mm<sup>2</sup>) to the lug and replace the nut to secure the wire.



3. Secure the other end of the ground wire to a grounded mast, pole, tower, or grounding bar.

## Connecting Ethernet

1. Use an S2 hex wrench to loosen the *Screw* and remove the port cover from the EdgePoint.



2. Feed the Ethernet cables through the *Cable Sleeve* and connect them to ports in this range: *eth0-eth7*.



**Note:** PoE is disabled by default.

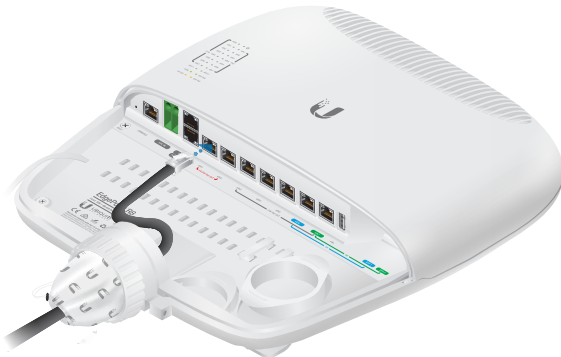



3. You can create a strain relief for any Ethernet cable by feeding a *Cable Tie* through the tie slot under the cable. Then wrap the *Cable Tie* around the cable and tighten.



4. Connect the other ends of the Ethernet cables to your network devices.

## Using SFP Ports (Optional)

For information about compatible fiber SFP modules, visit: [community.ubnt.com/edgemax](https://community.ubnt.com/edgemax)

To use an *SFP* port:

1. Plug a compatible fiber module into the *SFP* port.



**Note:** The corresponding RJ45 port will be deactivated.

2. Feed the fiber optic cable through the *Cable Sleeve*, and remove the cable jacket from the fiber optic cable.

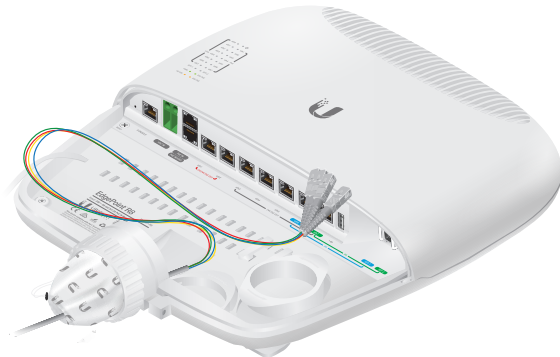

3. Separate the fiber optic strands and spool them around the strain relief reels in the direction of the arrows. Then connect a fiber optic strand to the fiber module.

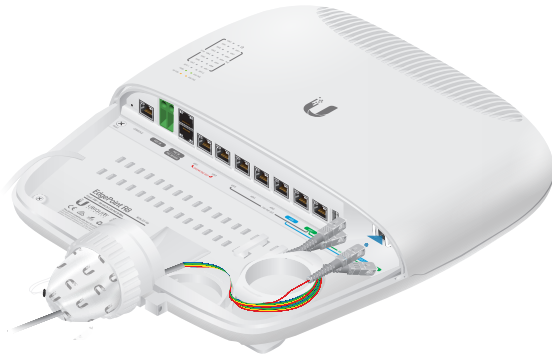

4. To finish the strain relief:
  - a. Feed a *Cable Tie* through the tie slot near the cable opening.
  - b. Feed an additional *Cable Tie* through the tie slots at the bottom of the strain relief reels.

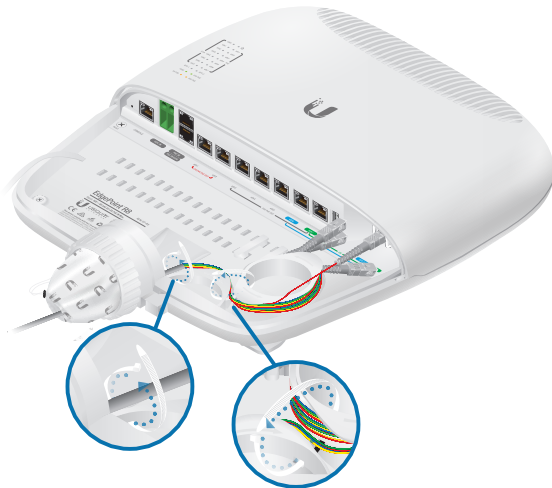

## Connecting to Power

Either the +42 to +56VDC input or PoE input is used at any one time. If both input types are connected, only the input type with the highest voltage will be used; the other can be used as a backup. Follow the appropriate instructions for your installation.

 **WARNING:** -48V is NOT supported.

## Connecting to the VDC Input

1. Wire one end of the DC power cable to the VDC terminal block, which uses auto-polarity detection.



2. Replace the port cover and use an S2 hex wrench to tighten the Screw and secure the port cover.



3. Wire the other end of the cable to a DC power supply.
4. Connect the DC power supply to its power source.

## Connecting Power Using PoE

The following instructions show the *PoE In / eth0* port; however, you can use the *PoE In* port above *eth0* instead.

Both PoE inputs can be used at the same time. If there is a voltage difference, the higher-voltage source will be used first. The voltage from the initial source will drop as the load increases. When the voltage drops to the same level as the lower-voltage source, then the lower-voltage source will also start providing power.

1. Connect an Ethernet cable to the *PoE In / eth0* port of the EdgePoint.



2. Connect the other end of the Ethernet cable to the **POE** port on the *Gigabit PoE* adapter.
3. Connect an Ethernet cable from the LAN to the **LAN** port on the *Gigabit PoE* adapter.
4. Connect the *Power Cord* to the *Gigabit PoE* adapter. Then plug the *Power Cord* into a power outlet.

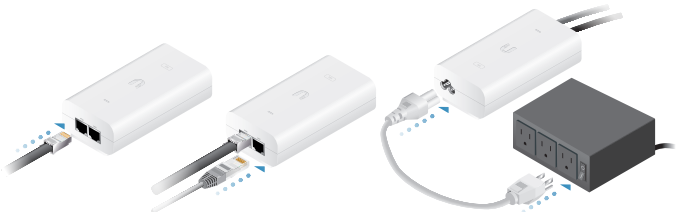

- When you are finished, replace the port cover and use an S2 hex wrench to tighten the Screw and secure the port cover.

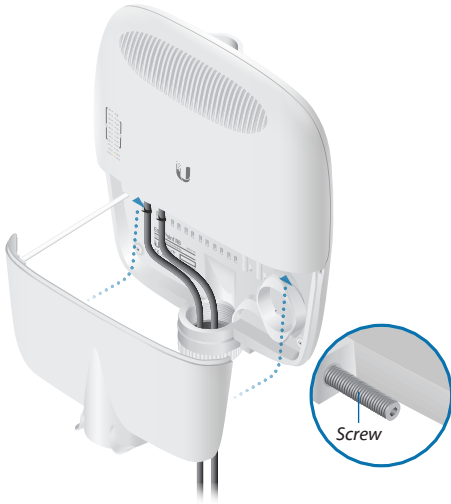

## Mounting the Gigabit PoE Adapter (Optional)

- Remove the *PoE Mounting Bracket* from the adapter, place the bracket at the desired location, and mark the two holes.
- Pre-drill the holes if necessary, and secure the bracket using the two *PoE Screws* and *Anchors*.
- Align the slots on the adapter with the tabs on the *PoE Mounting Bracket*, and then slide the adapter down.

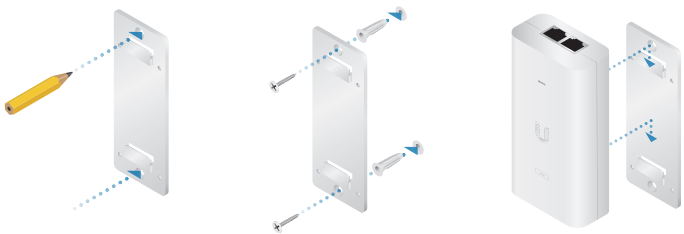

## Accessing the EdgeOS® Configuration Interface

 **Note:** Ensure that your host system is connected to the *Gigabit PoE* adapter or local network of the EdgePoint.

1. Configure the Ethernet adapter on your host system with a static IP address on the 192.168.1.x subnet.
2. Launch your web browser. Type **https://192.168.1.1** in the address field. Press **enter** (PC) or **return** (Mac).

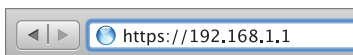

3. The login screen will appear. Enter **ubnt** in the *Username* and *Password* fields. Read the Ubiquiti License Agreement, and check the box next to *I agree to the terms of this License Agreement* to accept it. Click **Login**.

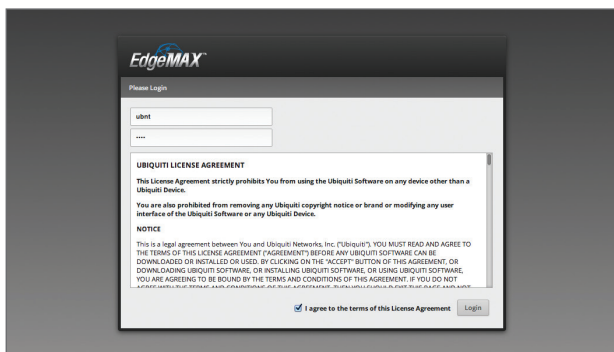

The EdgeOS Configuration Interface will appear, allowing you to customize your settings as needed. You can click the **Wizards** tab to access the Setup Wizard. For information on PoE configuration, refer to the *Configuring PoE Settings* section.

## Configuring PoE Settings

**! WARNING:** Before activating 54V or 24V passive PoE, ensure that the connected device supports PoE and the supplied voltage.

1. Go to **Actions > PoE** for the interface you want to configure.

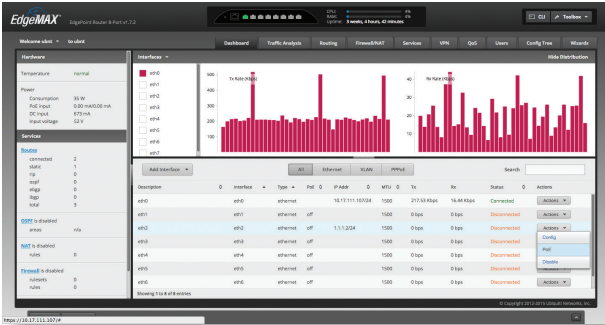

2. Configure the *PoE* setting:

- For *eth1-eth2*, select **Off**, **24V-4pair**, or **54V-4pair**.
- For *eth3-eth7*, select **Off** or **24V**.

Then click **Save**.

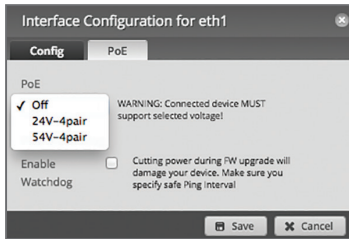

**Note:** If the *PoE* screen states that PoE is not supported, then there is insufficient power. You will need to increase the power input to the EdgePoint.

For more information, refer to the EdgeOS User Guide, which is available at [documentation.ubnt.com/edgemax](http://documentation.ubnt.com/edgemax)



## Specifications

EP-R8	
Dimensions With Wall-Mount	326.6 x 382.7 x 88.8 mm (12.86 x 15.07 x 3.50") 326.6 x 382.7 x 105.5 mm (12.86 x 15.07 x 4.15")
Weight With Wall-Mount	3.4 kg (7.50 lb) 3.8 kg (8.38 lb)
Max. Power Consumption	40W (Excludes PoE Output)
Power Input	(1) DC Terminal Block or (2) RJ45 (PoE In and eth0) (Self-Correcting Polarity Protection on DC Terminal Block Only, Diode ORed Protection on All Power Inputs)
Power Supply	Min. 54V / 0.8A (Excludes PoE Output Power)
VDC Input	54V / 6A
Passive PoE Input	(2) 54V / 1.5A, 4-Pair (+1, 2, 4, 5; -3, 6, 7, 8) Passive PoE, eth0 and PoE In (PoE In: DC Only)
Passive PoE Output	(2) 54V or 24V / 1.4A, 4-Pair (+1, 2, 4, 5; -3, 6, 7, 8) Passive PoE, eth1 to eth2 (5) 24V / 0.7A, 2-Pair (+4, 5; -7, 8) Passive PoE, eth3 to eth7
Power Monitoring	(1) DC Terminal Block, Input Power (2) RJ45, PoE In and eth0, Input Power
Supported Voltage Range	+42 to +56VDC (-48V is NOT Supported)
Button	Reset
LEDs	
System	Power
eth0	Speed/Link/Activity
eth1 to eth7	Speed/Link/Activity, PoE
SFP	Speed/Link/Activity
Ports	
Serial Console Port	(1) RJ45 Serial Port
PoE In Port	(1) RJ45 Port
Data Ports	(6) 10/100/1000 RJ45 Ports (2) 10/100/1000 RJ45/SFP Combination Ports
Processor	Dual-Core 600 MHz, MIPS64 with Hardware Acceleration for Packet Processing
System Memory	2 GB DDR3-1600 RAM
Code Storage	4 GB
Certifications	CE, FCC, IC
Pole/Wall Mount	Yes
Operating Temperature	-40 to 65° C (-40 to 149° F)
Operating Humidity	10 - 90% Noncondensing

## Safety Notices

1. Read, follow, and keep these instructions.
2. Heed all warnings.
3. Only use attachments/accessories specified by the manufacturer.



**WARNING:** Do not use this product in location that can be submerged by water.



**WARNING:** Avoid using this product during an electrical storm. There may be a remote risk of electric shock from lightning.

## Electrical Safety Information

1. Compliance is required with respect to voltage, frequency, and current requirements indicated on the manufacturer's label. Connection to a different power source than those specified may result in improper operation, damage to the equipment or pose a fire hazard if the limitations are not followed.
2. There are no operator serviceable parts inside this equipment. Service should be provided only by a qualified service technician.
3. This equipment is provided with a detachable power cord which has an integral safety ground wire intended for connection to a grounded safety outlet.
  - a. Do not substitute the power cord with one that is not the provided approved type. Never use an adapter plug to connect to a 2-wire outlet as this will defeat the continuity of the grounding wire.
  - b. The equipment requires the use of the ground wire as a part of the safety certification, modification or misuse can provide a shock hazard that can result in serious injury or death.
  - c. Contact a qualified electrician or the manufacturer if there are questions about the installation prior to connecting the equipment.
  - d. Protective earthing is provided by Listed AC adapter. Building installation shall provide appropriate short-circuit backup protection.
  - e. Protective bonding must be installed in accordance with local national wiring rules and regulations.

## Limited Warranty

UBIQUITI NETWORKS, Inc (“UBIQUITI NETWORKS”) warrants that the product(s) furnished hereunder (the “Product(s)”) shall be free from defects in material and workmanship for a period of one (1) year from the date of shipment by UBIQUITI NETWORKS under normal use and operation. UBIQUITI NETWORKS’ sole and exclusive obligation and liability under the foregoing warranty shall be for UBIQUITI NETWORKS, at its discretion, to repair or replace any Product that fails to conform to the above warranty during the above warranty period. The expense of removal and reinstallation of any Product is not included in this warranty. The warranty period of any repaired or replaced Product shall not extend beyond its original term.

## Warranty Conditions

The above warranty does not apply if the Product:

- (I) has been modified and/or altered, or an addition made thereto, except by Ubiquiti Networks, or Ubiquiti Networks’ authorized representatives, or as approved by Ubiquiti Networks in writing;
- (II) has been painted, rebranded or physically modified in any way;
- (III) has been damaged due to errors or defects in cabling;
- (IV) has been subjected to misuse, abuse, negligence, abnormal physical, electromagnetic or electrical stress, including lightning strikes, or accident;
- (V) has been damaged or impaired as a result of using third party firmware;
- (VI) has no original Ubiquiti MAC label, or is missing any other original Ubiquiti label(s); or
- (VII) has not been received by Ubiquiti within 30 days of issuance of the RMA.

In addition, the above warranty shall apply only if: the product has been properly installed and used at all times in accordance, and in all material respects, with the applicable Product documentation; all Ethernet cabling runs use CAT5 (or above), and for outdoor installations, shielded Ethernet cabling is used, and for indoor installations, indoor cabling requirements are followed.

## Returns

No Products will be accepted for replacement or repair without obtaining a Return Materials Authorization (RMA) number from UBIQUITI NETWORKS during the warranty period, and the Products being received at UBIQUITI NETWORKS' facility freight prepaid in accordance with the RMA process of UBIQUITI NETWORKS. Products returned without an RMA number will not be processed and will be returned freight collect or subject to disposal. Information on the RMA process and obtaining an RMA number can be found at: **[www.ubnt.com/support/warranty](http://www.ubnt.com/support/warranty)**.

## Disclaimer

EXCEPT FOR ANY EXPRESS WARRANTIES PROVIDED HEREIN, UBIQUITI NETWORKS, ITS AFFILIATES, AND ITS AND THEIR THIRD PARTY DATA, SERVICE, SOFTWARE AND HARDWARE PROVIDERS HEREBY DISCLAIM AND MAKE NO OTHER REPRESENTATION OR WARRANTY OF ANY KIND, EXPRESS, IMPLIED OR STATUTORY, INCLUDING, BUT NOT LIMITED TO, REPRESENTATIONS, GUARANTEES, OR WARRANTIES OF MERCHANTABILITY, ACCURACY, QUALITY OF SERVICE OR RESULTS, AVAILABILITY, SATISFACTORY QUALITY, LACK OF VIRUSES, QUIET ENJOYMENT, FITNESS FOR A PARTICULAR PURPOSE AND NON-INFRINGEMENT AND ANY WARRANTIES ARISING FROM ANY COURSE OF DEALING, USAGE OR TRADE PRACTICE IN CONNECTION WITH SUCH PRODUCTS AND SERVICES. BUYER ACKNOWLEDGES THAT NEITHER UBIQUITI NETWORKS NOR ITS THIRD PARTY PROVIDERS CONTROL BUYER'S EQUIPMENT OR THE TRANSFER OF DATA OVER COMMUNICATIONS FACILITIES, INCLUDING THE INTERNET, AND THAT THE PRODUCTS AND SERVICES MAY BE SUBJECT TO LIMITATIONS, INTERRUPTIONS, DELAYS, CANCELLATIONS AND OTHER PROBLEMS INHERENT IN THE USE OF COMMUNICATIONS FACILITIES. UBIQUITI NETWORKS, ITS AFFILIATES AND ITS AND THEIR THIRD PARTY PROVIDERS ARE NOT RESPONSIBLE FOR ANY INTERRUPTIONS, DELAYS, CANCELLATIONS, DELIVERY FAILURES, DATA LOSS, CONTENT CORRUPTION, PACKET LOSS, OR OTHER DAMAGE RESULTING FROM ANY OF THE FOREGOING. In addition, UBIQUITI NETWORKS does not warrant that the operation of the Products will be error-free or that operation will be uninterrupted. In no event shall UBIQUITI NETWORKS be responsible for damages or claims of any nature or description relating to system performance, including coverage, buyer's selection of products (including the Products) for buyer's application and/or failure of products (including the Products) to meet government or regulatory requirements.

## Limitation of Liability

EXCEPT TO THE EXTENT PROHIBITED BY LOCAL LAW, IN NO EVENT WILL UBIQUITI OR ITS SUBSIDIARIES, AFFILIATES OR SUPPLIERS BE LIABLE FOR DIRECT, SPECIAL, INCIDENTAL, CONSEQUENTIAL OR OTHER DAMAGES (INCLUDING LOST PROFIT, LOST DATA, OR DOWNTIME COSTS), ARISING OUT OF THE USE, INABILITY TO USE, OR THE RESULTS OF USE OF THE PRODUCT, WHETHER BASED IN WARRANTY, CONTRACT, TORT OR OTHER LEGAL THEORY, AND WHETHER OR NOT ADVISED OF THE POSSIBILITY OF SUCH DAMAGES.

### Note

Some countries, states and provinces do not allow exclusions of implied warranties or conditions, so the above exclusion may not apply to you. You may have other rights that vary from country to country, state to state, or province to province. Some countries, states and provinces do not allow the exclusion or limitation of liability for incidental or consequential damages, so the above limitation may not apply to you. EXCEPT TO THE EXTENT ALLOWED BY LOCAL LAW, THESE WARRANTY TERMS DO NOT EXCLUDE, RESTRICT OR MODIFY, AND ARE IN ADDITION TO, THE MANDATORY STATUTORY RIGHTS APPLICABLE TO THE LICENSE OF ANY SOFTWARE (EMBEDDED IN THE PRODUCT) TO YOU. The United Nations Convention on Contracts for the International Sale of Goods shall not apply to any transactions regarding the sale of the Products.

## Compliance

### FCC

Changes or modifications not expressly approved by the party responsible for compliance could void the user's authority to operate the equipment.

This device complies with Part 15 of the FCC Rules. Operation is subject to the following two conditions:

1. This device may not cause harmful interference, and
2. This device must accept any interference received, including interference that may cause undesired operation.

NOTE: This equipment has been tested and found to comply with the limits for a Class A digital device, pursuant to part 15 of the FCC Rules. These limits are designed to provide reasonable protection against harmful interference when the equipment is operated in a commercial environment. This equipment generates, uses, and can radiate radio frequency energy and, if not installed and used in accordance with the instruction manual, may cause harmful interference to radio communications. Operations of this equipment in a residential area is likely to cause harmful interference in which case the user will be required to correct the interference at his own expense.

### Industry Canada

#### CAN ICES-3(A)/NMB-3(A)

This Class A digital apparatus complies with Canadian CAN ICES-003.

#### CAN ICES-3(A)/NMB-3(A)

Cet appareil numérique de la classe A est conforme à la norme NMB-003 du Canada.

### Australia and New Zealand



Warning: This is a Class A product. In a domestic environment this product may cause radio interference in which case the user may be required to take adequate measures.

### CE Marking

CE marking on this product represents the product is in compliance with all directives that are applicable to it.



## RoHS/WEEE Compliance Statement



### English

European Directive 2012/19/EU requires that the equipment bearing this symbol on the product and/or its packaging must not be disposed of with unsorted municipal waste. The symbol indicates that this product should be disposed of separately from regular household waste streams. It is your responsibility to dispose of this and other electric and electronic equipment via designated collection facilities appointed by the government or local authorities. Correct disposal and recycling will help prevent potential negative consequences to the environment and human health. For more detailed information about the disposal of your old equipment, please contact your local authorities, waste disposal service, or the shop where you purchased the product.

### Deutsch

Die Europäische Richtlinie 2012/19/EU verlangt, dass technische Ausrüstung, die direkt am Gerät und/oder an der Verpackung mit diesem Symbol versehen ist, nicht zusammen mit unsortiertem Gemeindeabfall entsorgt werden darf. Das Symbol weist darauf hin, dass das Produkt von regulärem Haushaltsmüll getrennt entsorgt werden sollte. Es liegt in Ihrer Verantwortung, dieses Gerät und andere elektrische und elektronische Geräte über die dafür zuständigen und von der Regierung oder örtlichen Behörden dazu bestimmten Sammelstellen zu entsorgen. Ordnungsgemäßes Entsorgen und Recyceln trägt dazu bei, potentielle negative Folgen für Umwelt und die menschliche Gesundheit zu vermeiden. Wenn Sie weitere Informationen zur Entsorgung Ihrer Altgeräte benötigen, wenden Sie sich bitte an die örtlichen Behörden oder städtischen Entsorgungsdienste oder an den Händler, bei dem Sie das Produkt erworben haben.

## Español

La Directiva 2012/19/UE exige que los equipos que lleven este símbolo en el propio aparato y/o en su embalaje no deben eliminarse junto con otros residuos urbanos no seleccionados. El símbolo indica que el producto en cuestión debe separarse de los residuos domésticos convencionales con vistas a su eliminación. Es responsabilidad suya desechar este y cualesquiera otros aparatos eléctricos y electrónicos a través de los puntos de recogida que ponen a su disposición el gobierno y las autoridades locales. Al desechar y reciclar correctamente estos aparatos estará contribuyendo a evitar posibles consecuencias negativas para el medio ambiente y la salud de las personas. Si desea obtener información más detallada sobre la eliminación segura de su aparato usado, consulte a las autoridades locales, al servicio de recogida y eliminación de residuos de su zona o pregunte en la tienda donde adquirió el producto.

## Français

La directive européenne 2012/19/UE exige que l'équipement sur lequel est apposé ce symbole sur le produit et/ou son emballage ne soit pas jeté avec les autres ordures ménagères. Ce symbole indique que le produit doit être éliminé dans un circuit distinct de celui pour les déchets des ménages. Il est de votre responsabilité de jeter ce matériel ainsi que tout autre matériel électrique ou électronique par les moyens de collecte indiqués par le gouvernement et les pouvoirs publics des collectivités territoriales. L'élimination et le recyclage en bonne et due forme ont pour but de lutter contre l'impact néfaste potentiel de ce type de produits sur l'environnement et la santé publique. Pour plus d'informations sur le mode d'élimination de votre ancien équipement, veuillez prendre contact avec les pouvoirs publics locaux, le service de traitement des déchets, ou l'endroit où vous avez acheté le produit.

## Italiano

La direttiva europea 2012/19/UE richiede che le apparecchiature contrassegnate con questo simbolo sul prodotto e/o sull'imballaggio non siano smaltite insieme ai rifiuti urbani non differenziati. Il simbolo indica che questo prodotto non deve essere smaltito insieme ai normali rifiuti domestici. È responsabilità del proprietario smaltire sia questi prodotti sia le altre apparecchiature elettriche ed elettroniche mediante le specifiche strutture di raccolta indicate dal governo o dagli enti pubblici locali. Il corretto smaltimento ed il riciclaggio aiuteranno a prevenire conseguenze potenzialmente negative per l'ambiente e per la salute dell'essere umano. Per ricevere informazioni più dettagliate circa lo smaltimento delle vecchie apparecchiature in Vostro possesso, Vi invitiamo a contattare gli enti pubblici di competenza, il servizio di smaltimento rifiuti o il negozio nel quale avete acquistato il prodotto.



## Declaration of Conformity

Česky [Czech]	UBIQUITI NETWORKS tímto prohlašuje, že toto UBIQUITI NETWORKS zařízení, je ve shod se základními požadavky a dalšími příslušnými ustanoveními směrnic 2014/30/EU, 2014/35/EU.
Dansk [Danish]	Hermed, UBIQUITI NETWORKS, erklærer at denne UBIQUITI NETWORKS enhed, er i overensstemmelse med de væsentlige krav og øvrige relevante krav i direktiver 2014/30/EU, 2014/35/EU.
Nederlands [Dutch]	Hierbij verklaart UBIQUITI NETWORKS, dat deze UBIQUITI NETWORKS apparaat, in overeenstemming is met de essentiële eisen en de andere relevante bepalingen van richtlijnen 2014/30/EU, 2014/35/EU.
English	Hereby, UBIQUITI NETWORKS, declares that this UBIQUITI NETWORKS device, is in compliance with the essential requirements and other relevant provisions of Directives 2014/30/EU, 2014/35/EU.
Eesti [Estonian]	Käesolevaga UBIQUITI NETWORKS kinnitab, et antud UBIQUITI NETWORKS seade, on vastavus olulistele nõuetele ja teistele asjakohastele sätetele direktiivide 2014/30/EL, 2014/35/EL.
Suomi [Finnish]	Täten UBIQUITI NETWORKS vakuuttaa, että tämä UBIQUITI NETWORKS laite, on yhdenmukainen olennaisten vaatimusten ja muiden sitä koskevien direktiivien 2014/30/EU, 2014/35/EU.
Français [French]	Par la présente UBIQUITI NETWORKS déclare que l'appareil UBIQUITI NETWORKS, est conforme aux exigences essentielles et aux autres dispositions pertinentes des directives 2014/30/UE, 2014/35/UE.
Deutsch [German]	Hiermit erklärt UBIQUITI NETWORKS, dass sich dieses UBIQUITI NETWORKS Gerät, in Übereinstimmung mit den grundlegenden Anforderungen und den anderen relevanten Vorschriften der Richtlinien 2014/30/EU, 2014/35/EU befindet.
Ελληνική [Greek]	Δια του παρόντος, UBIQUITI NETWORKS, δηλώνει ότι αυτή η συσκευή UBIQUITI NETWORKS, είναι σε συμμόρφωση με τις βασικές απαιτήσεις και τις λοιπές σχετικές διατάξεις των οδηγιών 2014/30/EE, 2014/35/EE.
Magyar [Hungarian]	Ezennel UBIQUITI NETWORKS kijelenti, hogy ez a UBIQUITI NETWORKS készülék megfelel az alapvető követelményeknek és más vonatkozó 2014/30/EU, 2014/35/EU irányelvek rendelkezéseit.
Íslenska [Icelandic]	Hér, UBIQUITI NETWORKS, því yfir að þetta UBIQUITI NETWORKS tæki er í samræmi við grunnkröfur og önnur viðeigandi ákvæði tilskipana 2014/30/ESB, 2014/35/ESB.
Italiano [Italian]	Con la presente, UBIQUITI NETWORKS, dichiara che questo dispositivo UBIQUITI NETWORKS, è conforme ai requisiti essenziali ed alle altre disposizioni pertinenti delle direttive 2014/30/UE, 2014/35/UE.
Latviski [Latvian]	Ar šo, UBIQUITI NETWORKS, deklarē, ka UBIQUITI NETWORKS ierīce, ir saskaņā ar būtiskajām prasībām un citiem attiecīgiem noteikumiem Direktīvās 2014/30/ES, 2014/35/ES.
Lietuviškai [Lithuanian]	UBIQUITI NETWORKS deklaruoja, kad šis UBIQUITI NETWORKS įrenginys atitinka esminius reikalavimus ir kitas 2014/30/ES, 2014/35/ES Direktyvų nuostatas.

<b>Malti</b> [Maltese]	Hawnhekk, UBIQUITI NETWORKS, tiddikjara li dan il-mezz UBIQUITI NETWORKS huwa konformi mar-rekwiżiti essenzjali u dispożizzjonijiet rilevanti oħrajn ta' Direttivi 2014/30/UE, 2014/35/UE.
<b>Norsk</b> [Norwegian]	Herved UBIQUITI NETWORKS, erklærer at denne UBIQUITI NETWORKS enheten, er i samsvar med de grunnleggende kravene og andre relevante bestemmelser i direktivene 2014/30/EU, 2014/35/EU.
<b>Polски</b> [Polish]	Niniejszym, Ubiquiti Networks, oświadcza, że urządzenie UBIQUITI NETWORKS, jest zgodny z zasadniczymi wymaganiami oraz pozostałymi stosownymi postanowieniami Dyrektyw 2014/30/UE, 2014/35/UE.
<b>Português</b> [Portuguese]	UBIQUITI NETWORKS declara que este dispositivo UBIQUITI NETWORKS, está conforme com os requisitos essenciais e outras disposições das Directivas 2014/30/UE, 2014/35/UE.
<b>Română</b> [Romanian]	Prin prezenta, UBIQUITI NETWORKS declară că acest dispozitiv UBIQUITI NETWORKS este în conformitate cu cerințele esențiale și alte prevederi relevante ale Directivelor 2014/30/UE, 2014/35/UE.
<b>Slovensky</b> [Slovak]	Týmto UBIQUITI NETWORKS, prehlasuje, že toto UBIQUITI NETWORKS zariadenie, je v súlade so základnými požiadavkami a ďalšími relevantnými ustanoveniami smernice 2014/30/EÚ, 2014/35/EÚ.
<b>Español</b> [Spanish]	Por medio de la presente UBIQUITI NETWORKS declara que este dispositivo UBIQUITI NETWORKS, cumple con los requisitos esenciales y cualesquiera otras disposiciones aplicables o exigibles de las Directivas 2014/30/UE, 2014/35/UE.
<b>Svenska</b> [Swedish]	Härmed UBIQUITI NETWORKS, intygar att denna UBIQUITI NETWORKS enhet är i överensstämmelse med de väsentliga egenskapskrav och övriga relevanta bestämmelser som framgår av direktiven 2014/30/EU, 2014/35/EU.

## Online Resources

Support [support.ubnt.com](http://support.ubnt.com)

Community [community.ubnt.com](http://community.ubnt.com)

Downloads [downloads.ubnt.com](http://downloads.ubnt.com)





[www.ubnt.com](http://www.ubnt.com)

© 2015-2016 Ubiquiti Networks, Inc. All rights reserved. Ubiquiti, Ubiquiti Networks, the Ubiquiti U logo, the Ubiquiti beam logo, airFiber, airMAX, EdgeMAX, EdgeOS, EdgePoint, EdgePower, FiberProtect, PicoStation, and TOUGH Cable are trademarks or registered trademarks of Ubiquiti Networks, Inc. in the United States and in other countries. All other trademarks are the property of their respective owners.



640-00165-07